

# Stamped pin IC Sockets PTN

PCN Number	PTNTAI190424
Publication Date	02/05/2024
Effectivity Date	01/06/2024
Change Summary	END OF LIFE
Last Time Buy	01/06/2024
Last Time Ship	N.A

## Functionality change

TSDxx Products are end of life

## Details of Change

The TSDxx series will be discontinued with effect from 1/6/2024. There is a Taicom alternative available from the Turned Pin series, TTDxx.

The full list of part numbers is detailed below along with the Turned Pin alternative.

## Reason for change

Due to very low demand and declining sales on Taicoms Dual in Line Stamped Pin IC sockets

## Appendix contents

Data sheets for both the TSD and TTD series are attached for your reference.

These changes apply with immediate effect to shipments from manufacturer to Anglia. Anglia operates a strict FIFO system in our Distribution Centre facility; therefore, it may take time for this change to filter through to customer deliveries of the below part number(s).

Please make the relevant person(s) in your organisation aware of this change.

Yours Sincerely

Anglia

## Affected Part Numbers

PCN/PTN Number	Anglia Part Number	Alternate Part Number	Brand
PTNTAI190424	TSD06	TTD06	Taicom
PTNTAI190424	TSD08	TTD08	Taicom
PTNTAI190424	TSD14	TTD14	Taicom
PTNTAI190424	TSD16	TTD16	Taicom
PTNTAI190424	TSD18	TTD18	Taicom
PTNTAI190424	TSD20	TTD20	Taicom
PTNTAI190424	TSD22A	CONSULT ANGLIA	Taicom
PTNTAI190424	TSD22	TTD22	Taicom
PTNTAI190424	TSD24A	TTD24A	Taicom
PTNTAI190424	TSD24	TTD24	Taicom
PTNTAI190424	TSD28A	TTD28A	Taicom
PTNTAI190424	TSD28	TTD28	Taicom
PTNTAI190424	TSD32	TTD32	Taicom
PTNTAI190424	TSD32A	TTD32A	Taicom
PTNTAI190424	TSD40	TTD40	Taicom
PTNTAI190424	TSD42	Consult Anglia	Taicom
PTNTAI190424	TSD42A	TTD42A	Taicom
PTNTAI190424	TSD48	TTD48	Taicom
PTNTAI190424	TSD56A	TTD56A	Taicom

## Appendix

Document	Location	Date
TSDXX DATASHEET	Below	02/05/2024
TTDXX DATASHEET	Below	02/05/2024

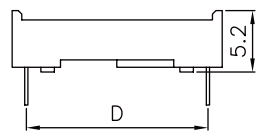
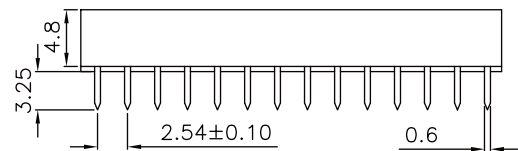
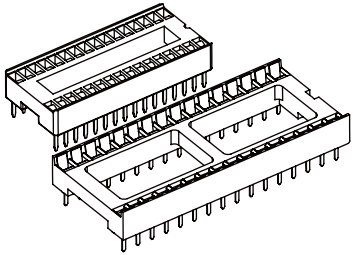
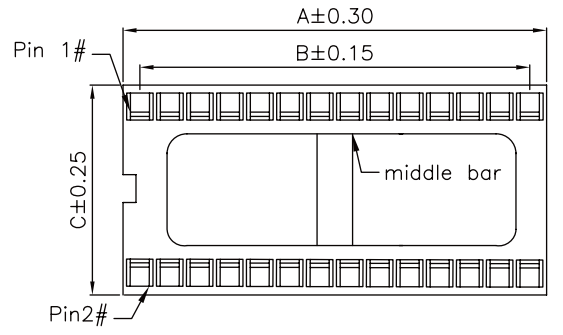

Note1: W/O middle bar(6~20P)  
With middle bar(22~48P)

Dimension:

Circuits	DIM.A	DIM.B	DIM.C	DIM.D	Spacing	Circuits	DIM.A	DIM.B	DIM.C	DIM.D	Spacing	
6	7.62	5.08	10.16	7.62	03	22	27.94	25.40	12.70	10.16	04	
8	10.16	7.62	10.16	7.62		24	30.48	27.94	17.78	15.24	06	
14	17.78	15.24	10.16	7.62		28	35.56	33.02	17.78	15.24		
16	20.32	17.78	10.16	7.62		32	40.64	38.10	17.78	15.24		
18	22.86	20.32	10.16	7.62		40	50.80	48.26	17.78	15.24		
20	25.40	22.86	10.16	7.62		42	53.34	50.80	17.78	15.24		
24	30.48	27.94	10.16	7.62		48	60.96	58.42	17.78	15.24		
28	35.56	33.02	10.16	7.62								

### SPECIFICATION

Current Rating : 1A AC/DC  
 Voltage Rating : 250V AC/DC  
 Operation Temperature : -40°C to +105°C  
 Contact Resistance : 15mΩ max.  
 Insulation Resistance : 5000MΩ Min.  
 Withstand Voltage : 1000V AC/minute  
 Material :  
 Insulator : PB.T., UL94V-0  
 Standard Colour : Black  
 Contact : Copper Alloy  
 Finish : Tin Plated

No. of ways	Pitch between rows (inch)	Part Number
6 way	0.3	TSD06
8 way	0.3	TSD08
14 way	0.3	TSD14
16 way	0.3	TSD16
18 way	0.3	TSD18
20 way	0.3	TSD20
22 way	0.3	TSD22A
22 way	0.4	TSD22
24 way	0.3	TSD24A
24 way	0.6	TSD24
28 way	0.3	TSD28A
28 way	0.6	TSD28
32 way	0.6	TSD32
32 way*	0.4	TSD32A
40 way	0.6	TSD40
42 way	0.6	TSD42
42 way*	0.6	TSD42A
48 way	0.6	TSD48

\* TSD32A & TSD42A have 1.78mm Pin Spacing

RoHS Compliant

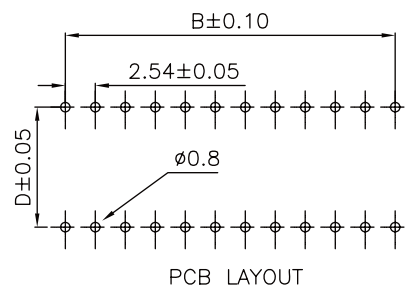

## Taicom TSDxx

Title : 2.54mm IC Socket Stamp Pin

Tolerance (Unless Specified) : .x = ±0.20  
.xx = ±0.15

Dim : (mm)

Angle :

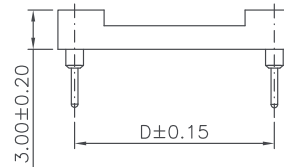
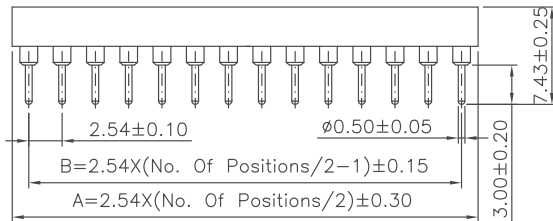
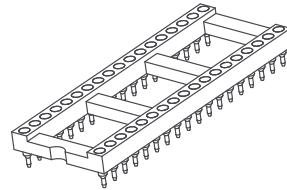
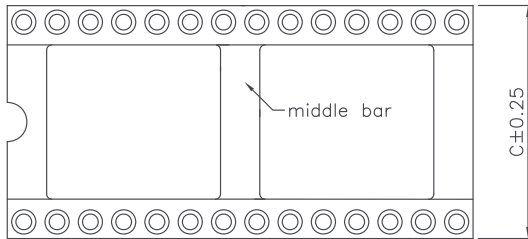

Note1: W/O middle bar(6~16P)  
With middle bar(18~48P)

Circuits	DIM.A	DIM.B	DIM.C	DIM.D	Space	Circuits	DIM.A	DIM.B	DIM.C	DIM.D	Space	
6	7.62	5.08	10.16	7.62	03	24	30.48	27.94	17.78	15.24	06	
8	10.16	7.62	10.16	7.62		28	35.56	33.02	17.78	15.24		
14	17.78	15.24	10.16	7.62		32	40.64	38.10	17.78	15.24		
16	20.32	17.78	10.16	7.62		40	50.80	48.26	17.78	15.24		
18	22.86	20.32	10.16	7.62		42	53.34	50.80	17.78	15.24		
20	25.40	22.86	10.16	7.62		48	60.96	58.42	17.78	15.24		
24	30.48	27.94	10.16	7.62								
28	35.56	33.02	10.16	7.62								

## SPECIFICATION

Current Rating :	1A AC/DC
Voltage Rating :	100V AC/DC
Operation Temperature :	-40°C to +105°C
Contact Resistance :	15mΩ max.
Insulation Resistance :	5000MΩ Min.
Withstand Voltage :	1000V AC/minute
Material	
Insulator :	P.B.T., UL94V-0
Standard Colour :	Black
Contact :	Beryllium Copper (Becu) Gold plated
Sleeve Barrel :	Copper Alloy Tin Plated

No. of ways	Pitch between rows (inch)	Part Number
6 way	0.3	TTD06
8 way	0.3	TTD08
14 way	0.3	TTD14
16 way	0.3	TTD16
18 way	0.3	TTD18
20 way	0.3	TTD20
22 way	0.4	TTD22
24 way	0.3	TTD24A
24 way	0.6	TTD24
28 way	0.3	TTD28A
28 way	0.6	TTD28
32 way	0.6	TTD32
32 way	0.4	TTD32A
36 way	0.6	TTD36
40 way	0.6	TTD40
42 way	0.6	TTD42A

RoHS Compliant

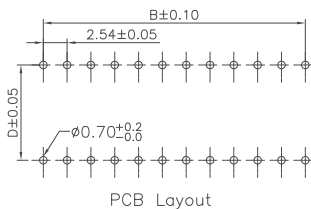

## Taicom TTDxxx

Title : 2.54mm IC Socket Machine Pin

Tolerance (Unless Specified) : .x = ±0.20  
.xx = ±0.15

Dim : (mm)

Angle :