

PCB SUPPORTS – single-ended snap Natural colour

Reverse locking pcb support with snap lock and a thin button head for minimal board protrusion.

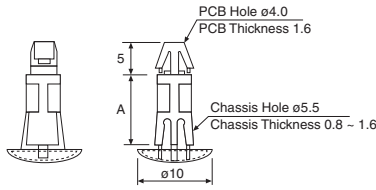
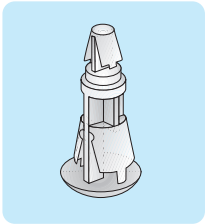

Length 'A' (mm)	Manf. Part No.	anglia Order Code
6.4	10R064	475132
8.0	10R080	475133
10.0	10R100	475134
12.7	10R127	475135
14.0	10R140	475136

Key locking pcb support with snap lock.

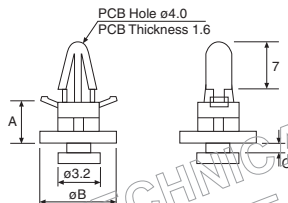
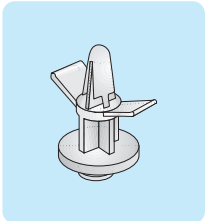

Dimensions (mm)			Manf. Part No.	anglia Order Code	Panel Cut-out
A	B	C			
5.0	11.7	1.3	10K050	475181	
6.4	11.6	1.3	10K063	475182	
8.0	11.6	1.4	10K080	475183	

PCB SUPPORTS – self-adhesive base Natural colour

Miniature size. Snap locking.

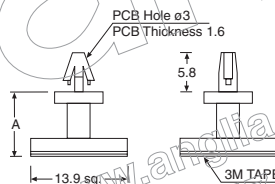
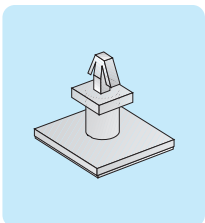

Length 'A' (mm)	Manf. Part No.	anglia Order Code
6.4	10A064M	475200
9.0	10A090M	475201
12.7	10A127M	475202

Snap locking.

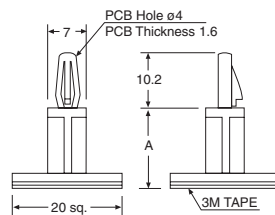
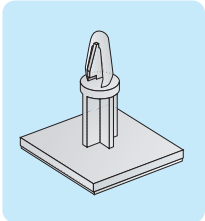

Length 'A' (mm)	Manf. Part No.	anglia Order Code
6.4	10A064	475230
9.5	10A095	475231
12.7	10A127	475232
15.9	10A159	475233

PCB SUPPORTS – snap locking for square hole Natural colour

Snap locking/releasable barb. Suitable for fitting into a square chassis hole.

NEW

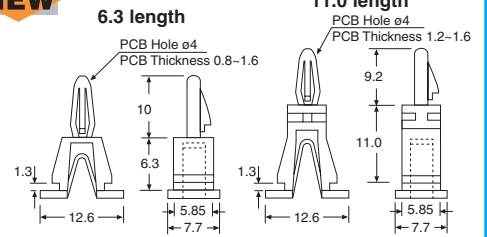
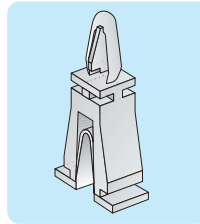

Length (mm)	Manf. Part No.	anglia Order Code
6.3	10SD063	475173
11.0	10SD110	475176

Panel Cut-out



PCB SUPPORTS – edge mount Natural colour

PCB edge supports with choice of snap locking, key locking or self-adhesive mounting method.

NEW

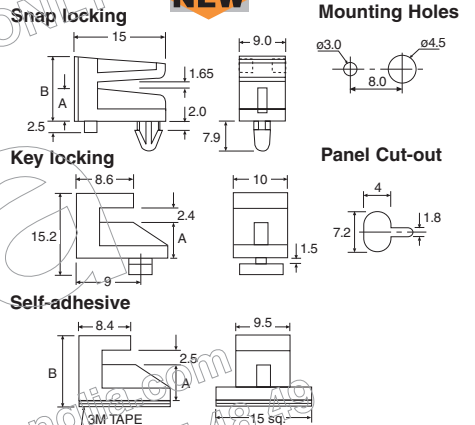
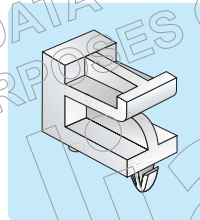

Fitting Method	Dimensions		Manf. Part No.	anglia Order Code
	A	B		
Snap locking	6.4	11.8	10EC064	475612
Snap locking	14	19.2	10EC140	475616
Key locking	6.3	-	10EK063	475622
Self-adhesive	6.0	11.3	10EA060	475632
Self-adhesive	8.0	12.8	10EA080	475633
Self-adhesive	10.0	15.0	10EA100	475634
Self-adhesive	11.0	15.8	10EA110	475635
Self-adhesive	12.0	17.0	10EA120	475636

PCB SUPPORTS – snap locking, releasable Natural colour

Snap locking into chassis with releasable board lock.

NEW

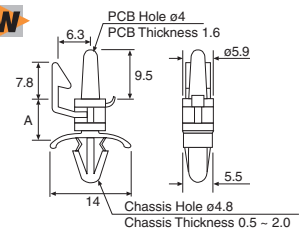
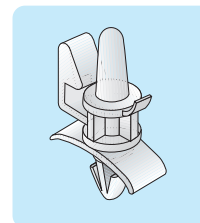

Length 'A' (mm)	Manf. Part No.	anglia Order Code
6.3	10B063	475193
8.0	10B080	475194
9.5	10B095	475195
12.7	10B127	475197
15.9	10B160	475198