

# ANGLiCON

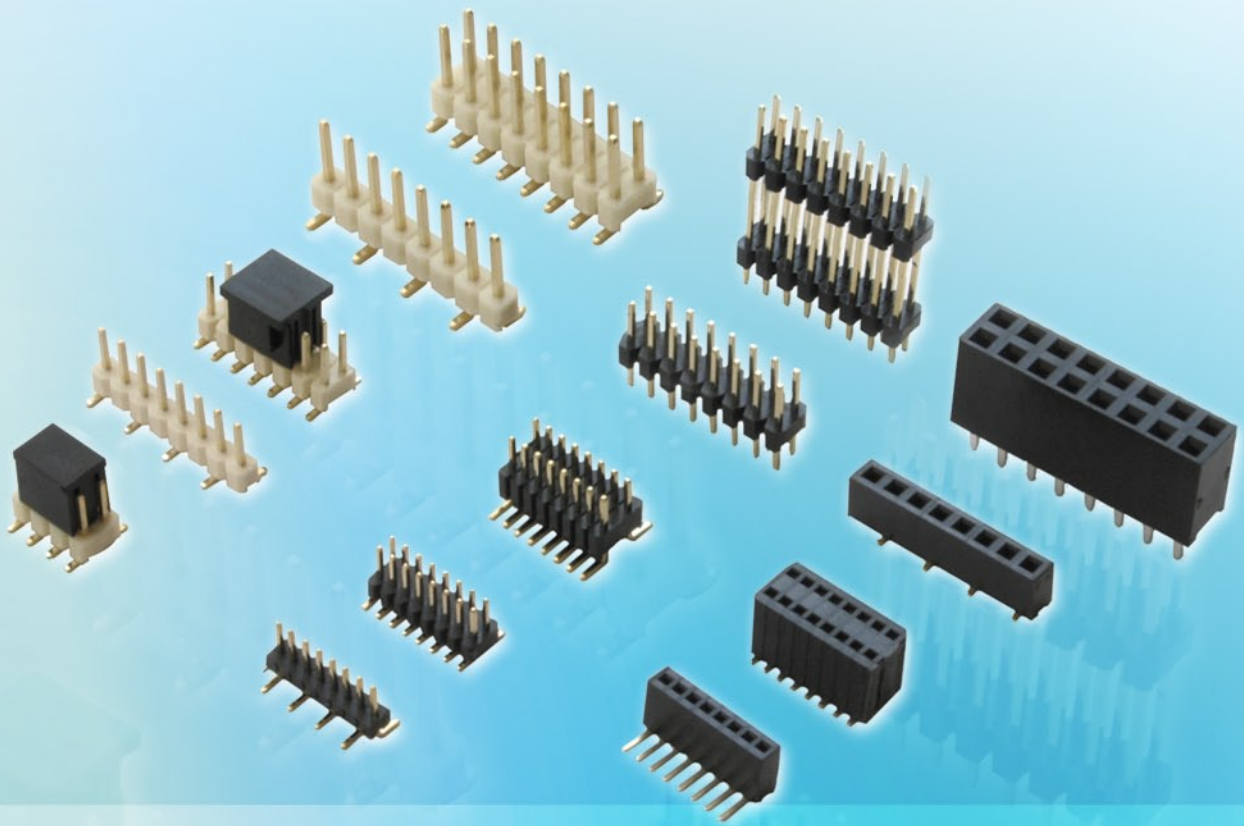

## Pin Headers and Sockets

Product selection

**anglia**

[www.anglia.com](http://www.anglia.com)

**TAICOM type TPH, TFH & TMJ**

**INTRODUCTION**

A wide range of pin headers and sockets available in a choice of industry standard pitch configurations with each size offering the option of mounting method, single or double row straight formats and amount of ways. Right angle versions and extended pin headers for board stacking are also listed together with mini jumper links in various styles and colours enabling a simple and cost effective solution to pcb interconnection. UL94V-0 flame retardant mouldings are employed throughout, many of which are end and side stackable, with pins and contacts gold over nickel plated for higher reliability. A family of turned pin headers and sockets completes the product line up.

- ◆ Range comprises of pin headers, sockets and jumper links
- ◆ Choice of **1.27, 1.27 x 2.54, 2.0 or 2.54mm pitch**
- ◆ Option of **SMD or through hole mounting**
- ◆ **Single and double row** available
- ◆ **Straight and right angle** versions provided
- ◆ Broad selection of ways
- ◆ **Extended pin headers included** for board spacing
- ◆ **Mini jumper links offered** in various styles/colours
- ◆ Gold over nickel pins and contacts
- ◆ Flame retardant insulators and bodies
- ◆ Creates a simple and cost effective connection system

**Specification**

**Pin Headers**

Termination pins .....	Copper alloy, gold over nickel plated
Insulators .....	Hi-temp plastic flame retardant to UL94V-0
Current rating .....	1A
Proof voltage .....	500Vac
Insulation resistance (min) at 500Vdc .....	1000MΩ
Operating temperature range .....	-25°C to +105°C

**Sockets**

Contacts .....	Phosphor bronze, gold over nickel plated on contact areas, tin plated over nickel on solder pins
Body .....	Hi-temp plastic flame retardant to UL94V-0
Current rating .....	1A
Proof voltage .....	500Vac
Contact resistance (max) .....	30mΩ
Insulation resistance (min) .....	1000MΩ
Operating temperature range .....	-25°C to +105°C

**Mini Jumper Links**

Contacts .....	Phosphor bronze, gold over nickel plated
Body .....	Hi-temp plastic flame retardant to UL94V-0 (open/closed only)
Current rating .....	1A
Proof voltage .....	250Vac (1.27mm) 500Vac (2.0 & 2.54mm pitch)
Contact resistance (max) .....	30mΩ
Insulation resistance (min) .....	1000MΩ
Operating temperature range .....	-25°C to +105°C

**INDEX**

**Pin Headers**

1.27mm Pitch	Pages 2 to 4
1.27 x 2.54mm Pitch	Page 8
2.0mm Pitch	Pages 10 to 11
2.54mm Pitch	Pages 15 to 17

**Extended Pin Headers**

Introduction	Page 21
1.27mm Pitch	Pages 22 to 23
1.27 x 2.54mm Pitch	Page 24
2.0mm Pitch	Pages 25 to 26
2.54mm Pitch	Pages 27 to 28

**Sockets**

1.27mm Pitch	Pages 5 to 7
1.27 x 2.54mm Pitch	Page 9
2.0mm Pitch	Pages 12 to 14
2.54mm Pitch	Pages 18 to 20

**Mini Jumper Links**

1.27mm Pitch	Page 7
2.0mm Pitch	Page 13
2.54mm Pitch	Page 21

**Turned Pin Headers & Sockets**

2.54mm Pitch	Page 29
--------------	---------

**Surface Mount**

A range of straight, surface mounting pin headers on a 1.27mm pitch available in single and double row.

**SINGLE ROW**

Choice of 2 to 40 ways.

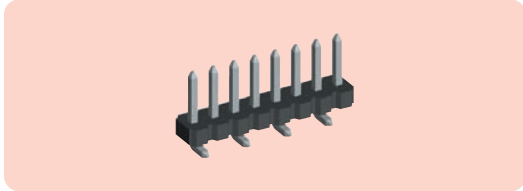

Type	Manf. Part No. & anglia Order Code
STRAIGHT	
2 way	TPH02CSSNB
3 way	TPH03CSSNB
4 way	TPH04CSSNB
5 way	TPH05CSSNB
6 way	TPH06CSSNB
7 way	TPH07CSSNB
8 way	TPH08CSSNB
9 way	TPH09CSSNB
10 way	TPH10CSSNB
11 way	TPH11CSSNB
12 way	TPH12CSSNB
13 way	TPH13CSSNB
14 way	TPH14CSSNB
15 way	TPH15CSSNB
16 way	TPH16CSSNB
17 way	TPH17CSSNB
18 way	TPH18CSSNB
19 way	TPH19CSSNB
20 way	TPH20CSSNB
21 way	TPH21CSSNB
22 way	TPH22CSSNB
23 way	TPH23CSSNB
24 way	TPH24CSSNB
25 way	TPH25CSSNB
26 way	TPH26CSSNB
27 way	TPH27CSSNB
28 way	TPH28CSSNB
29 way	TPH29CSSNB
30 way	TPH30CSSNB
31 way	TPH31CSSNB
32 way	TPH32CSSNB
33 way	TPH33CSSNB
34 way	TPH34CSSNB
35 way	TPH35CSSNB
36 way	TPH36CSSNB
37 way	TPH37CSSNB
38 way	TPH38CSSNB
39 way	TPH39CSSNB
40 way	TPH40CSSNB

**DOUBLE ROW**

Choice of 2 to 40 ways (4 to 80 pins).

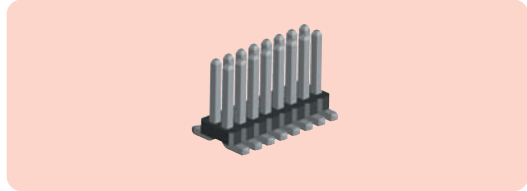

Type	Manf. Part No. & anglia Order Code
STRAIGHT	
2 way	TPH02CDSNB
3 way	TPH03CDSNB
4 way	TPH04CDSNB
5 way	TPH05CDSNB
6 way	TPH06CDSNB
7 way	TPH07CDSNB
8 way	TPH08CDSNB
9 way	TPH09CDSNB
10 way	TPH10CDSNB
11 way	TPH11CDSNB
12 way	TPH12CDSNB
13 way	TPH13CDSNB
14 way	TPH14CDSNB
15 way	TPH15CDSNB
16 way	TPH16CDSNB
17 way	TPH17CDSNB
18 way	TPH18CDSNB
19 way	TPH19CDSNB
20 way	TPH20CDSNB
21 way	TPH21CDSNB
22 way	TPH22CDSNB
23 way	TPH23CDSNB
24 way	TPH24CDSNB
25 way	TPH25CDSNB
26 way	TPH26CDSNB
27 way	TPH27CDSNB
28 way	TPH28CDSNB
29 way	TPH29CDSNB
30 way	TPH30CDSNB
31 way	TPH31CDSNB
32 way	TPH32CDSNB
33 way	TPH33CDSNB
34 way	TPH34CDSNB
35 way	TPH35CDSNB
36 way	TPH36CDSNB
37 way	TPH37CDSNB
38 way	TPH38CDSNB
39 way	TPH39CDSNB
40 way	TPH40CDSNB

**Dimensions (mm)**

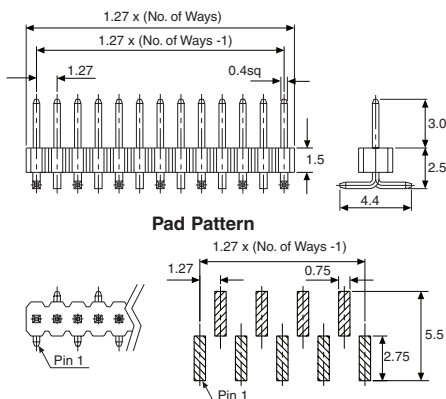

**Dimensions (mm)**

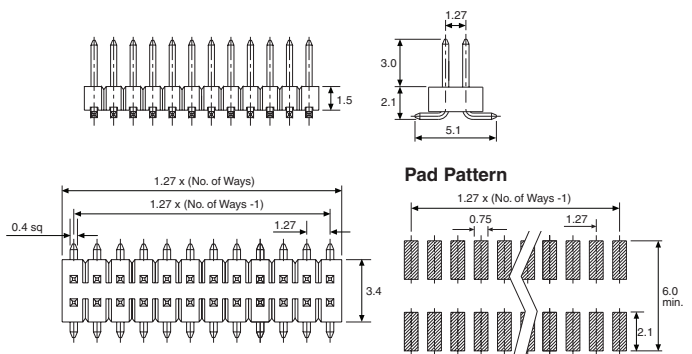

### Through Hole

A range of straight, through hole mounting pin headers on a 1.27mm pitch available in single and double row.

#### SINGLE ROW

Choice of 2 to 40 ways.

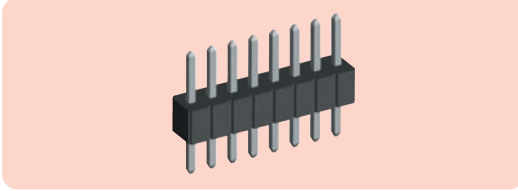

Type	Manf. Part No. & anglia Order Code
<b>STRAIGHT</b>	
2 way	TPH02CSS
3 way	TPH03CSS
4 way	TPH04CSS
5 way	TPH05CSS
6 way	TPH06CSS
7 way	TPH07CSS
8 way	TPH08CSS
9 way	TPH09CSS
10 way	TPH10CSS
11 way	TPH11CSS
12 way	TPH12CSS
13 way	TPH13CSS
14 way	TPH14CSS
15 way	TPH15CSS
16 way	TPH16CSS
17 way	TPH17CSS
18 way	TPH18CSS
19 way	TPH19CSS
20 way	TPH20CSS
21 way	TPH21CSS
22 way	TPH22CSS
23 way	TPH23CSS
24 way	TPH24CSS
25 way	TPH25CSS
26 way	TPH26CSS
27 way	TPH27CSS
28 way	TPH28CSS
29 way	TPH29CSS
30 way	TPH30CSS
31 way	TPH31CSS
32 way	TPH32CSS
33 way	TPH33CSS
34 way	TPH34CSS
35 way	TPH35CSS
36 way	TPH36CSS
37 way	TPH37CSS
38 way	TPH38CSS
39 way	TPH39CSS
40 way	TPH40CSS

#### Dimensions (mm)

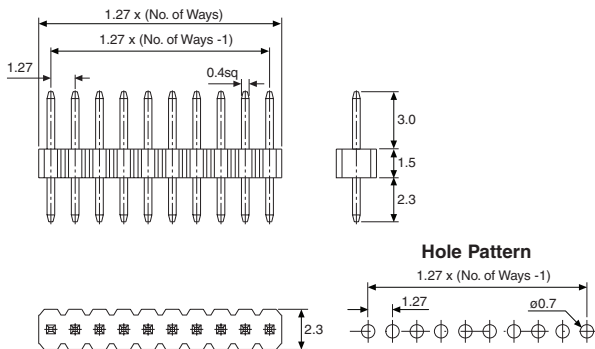

#### DOUBLE ROW

Choice of 2 to 40 ways (4 to 80 pins).

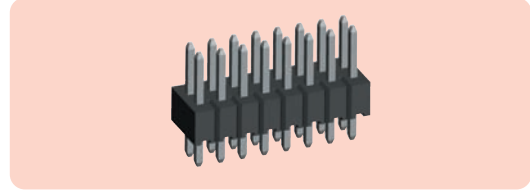

Type	Manf. Part No. & anglia Order Code
<b>STRAIGHT</b>	
2 way	TPH02CDS
3 way	TPH03CDS
4 way	TPH04CDS
5 way	TPH05CDS
6 way	TPH06CDS
7 way	TPH07CDS
8 way	TPH08CDS
9 way	TPH09CDS
10 way	TPH10CDS
11 way	TPH11CDS
12 way	TPH12CDS
13 way	TPH13CDS
14 way	TPH14CDS
15 way	TPH15CDS
16 way	TPH16CDS
17 way	TPH17CDS
18 way	TPH18CDS
19 way	TPH19CDS
20 way	TPH20CDS
21 way	TPH21CDS
22 way	TPH22CDS
23 way	TPH23CDS
24 way	TPH24CDS
25 way	TPH25CDS
26 way	TPH26CDS
27 way	TPH27CDS
28 way	TPH28CDS
29 way	TPH29CDS
30 way	TPH30CDS
31 way	TPH31CDS
32 way	TPH32CDS
33 way	TPH33CDS
34 way	TPH34CDS
35 way	TPH35CDS
36 way	TPH36CDS
37 way	TPH37CDS
38 way	TPH38CDS
39 way	TPH39CDS
40 way	TPH40CDS

#### Dimensions (mm)

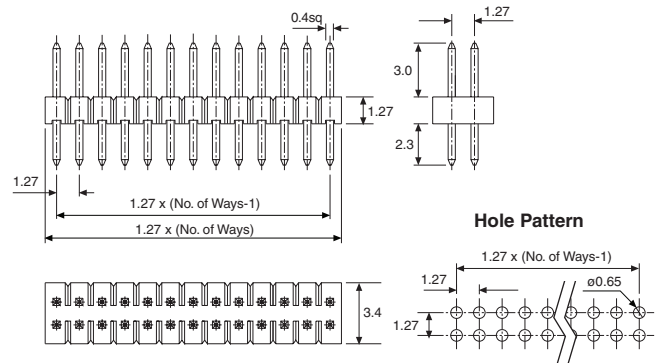

**Through Hole**

A range of right angle, through hole mounting pin headers on a 1.27mm pitch available in single and double row.

**SINGLE ROW**

Choice of 2 to 40 ways.

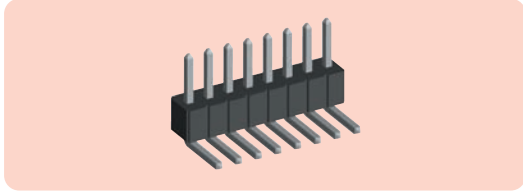

Type	Manf. Part No. & anglia Order Code
<b>RIGHT ANGLE</b>	
2 way	TPH02CSR
3 way	TPH03CSR
4 way	TPH04CSR
5 way	TPH05CSR
6 way	TPH06CSR
7 way	TPH07CSR
8 way	TPH08CSR
9 way	TPH09CSR
10 way	TPH10CSR
11 way	TPH11CSR
12 way	TPH12CSR
13 way	TPH13CSR
14 way	TPH14CSR
15 way	TPH15CSR
16 way	TPH16CSR
17 way	TPH17CSR
18 way	TPH18CSR
19 way	TPH19CSR
20 way	TPH20CSR
21 way	TPH21CSR
22 way	TPH22CSR
23 way	TPH23CSR
24 way	TPH24CSR
25 way	TPH25CSR
26 way	TPH26CSR
27 way	TPH27CSR
28 way	TPH28CSR
29 way	TPH29CSR
30 way	TPH30CSR
31 way	TPH31CSR
32 way	TPH32CSR
33 way	TPH33CSR
34 way	TPH34CSR
35 way	TPH35CSR
36 way	TPH36CSR
37 way	TPH37CSR
38 way	TPH38CSR
39 way	TPH39CSR
40 way	TPH40CSR

**DOUBLE ROW**

Choice of 2 to 40 ways (4 to 80 pins).

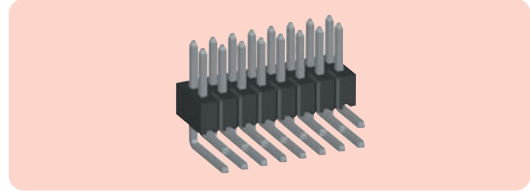

Type	Manf. Part No. & anglia Order Code
<b>RIGHT ANGLE</b>	
2 way	TPH02CDR
3 way	TPH03CDR
4 way	TPH04CDR
5 way	TPH05CDR
6 way	TPH06CDR
7 way	TPH07CDR
8 way	TPH08CDR
9 way	TPH09CDR
10 way	TPH10CDR
11 way	TPH11CDR
12 way	TPH12CDR
13 way	TPH13CDR
14 way	TPH14CDR
15 way	TPH15CDR
16 way	TPH16CDR
17 way	TPH17CDR
18 way	TPH18CDR
19 way	TPH19CDR
20 way	TPH20CDR
21 way	TPH21CDR
22 way	TPH22CDR
23 way	TPH23CDR
24 way	TPH24CDR
25 way	TPH25CDR
26 way	TPH26CDR
27 way	TPH27CDR
28 way	TPH28CDR
29 way	TPH29CDR
30 way	TPH30CDR
31 way	TPH31CDR
32 way	TPH32CDR
33 way	TPH33CDR
34 way	TPH34CDR
35 way	TPH35CDR
36 way	TPH36CDR
37 way	TPH37CDR
38 way	TPH38CDR
39 way	TPH39CDR
40 way	TPH40CDR

**Dimensions (mm)**

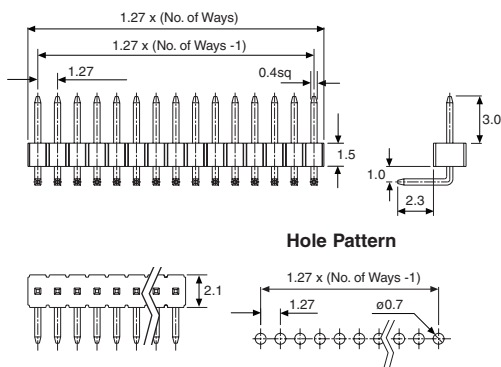

**Dimensions (mm)**

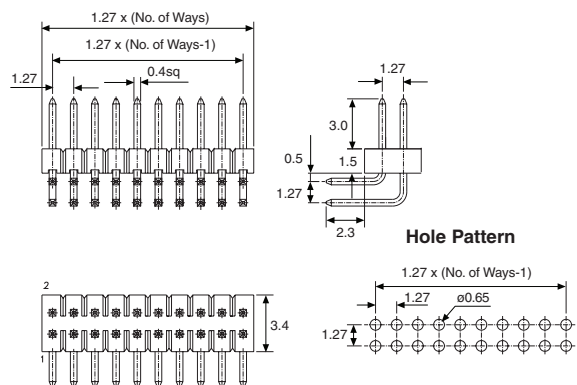

### Surface Mount

A range of straight, surface mounting sockets on a 1.27mm pitch available in single and double row.

#### SINGLE ROW

Choice of 2 to 40 ways.

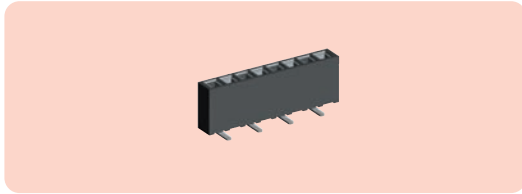

Type	Manf. Part No. & anglia Order Code
<b>STRAIGHT</b>	
2 way	TFH02CSSNB
3 way	TFH03CSSNB
4 way	TFH04CSSNB
5 way	TFH05CSSNB
6 way	TFH06CSSNB
7 way	TFH07CSSNB
8 way	TFH08CSSNB
9 way	TFH09CSSNB
10 way	TFH10CSSNB
11 way	TFH11CSSNB
12 way	TFH12CSSNB
13 way	TFH13CSSNB
14 way	TFH14CSSNB
15 way	TFH15CSSNB
16 way	TFH16CSSNB
17 way	TFH17CSSNB
18 way	TFH18CSSNB
19 way	TFH19CSSNB
20 way	TFH20CSSNB
21 way	TFH21CSSNB
22 way	TFH22CSSNB
23 way	TFH23CSSNB
24 way	TFH24CSSNB
25 way	TFH25CSSNB
26 way	TFH26CSSNB
27 way	TFH27CSSNB
28 way	TFH28CSSNB
29 way	TFH29CSSNB
30 way	TFH30CSSNB
31 way	TFH31CSSNB
32 way	TFH32CSSNB
33 way	TFH33CSSNB
34 way	TFH34CSSNB
35 way	TFH35CSSNB
36 way	TFH36CSSNB
37 way	TFH37CSSNB
38 way	TFH38CSSNB
39 way	TFH39CSSNB
40 way	TFH40CSSNB

#### Dimensions (mm)

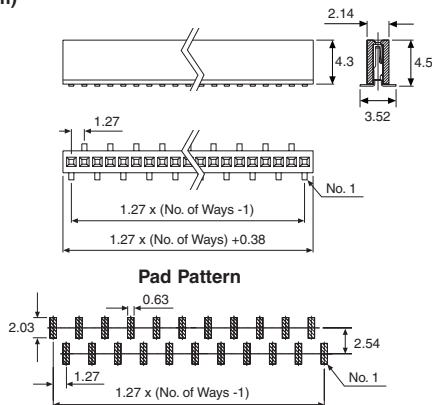

#### DOUBLE ROW

Choice of 2 to 40 ways (4 to 80 contacts).

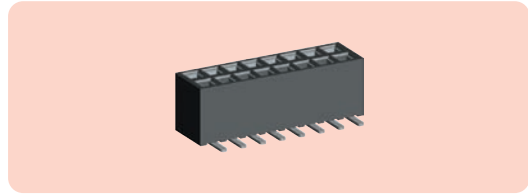

Type	Manf. Part No. & anglia Order Code
<b>STRAIGHT</b>	
2 way	TFH02CDSNB
3 way	TFH03CDSNB
4 way	TFH04CDSNB
5 way	TFH05CDSNB
6 way	TFH06CDSNB
7 way	TFH07CDSNB
8 way	TFH08CDSNB
9 way	TFH09CDSNB
10 way	TFH10CDSNB
11 way	TFH11CDSNB
12 way	TFH12CDSNB
13 way	TFH13CDSNB
14 way	TFH14CDSNB
15 way	TFH15CDSNB
16 way	TFH16CDSNB
17 way	TFH17CDSNB
18 way	TFH18CDSNB
19 way	TFH19CDSNB
20 way	TFH20CDSNB
21 way	TFH21CDSNB
22 way	TFH22CDSNB
23 way	TFH23CDSNB
24 way	TFH24CDSNB
25 way	TFH25CDSNB
26 way	TFH26CDSNB
27 way	TFH27CDSNB
28 way	TFH28CDSNB
29 way	TFH29CDSNB
30 way	TFH30CDSNB
31 way	TFH31CDSNB
32 way	TFH32CDSNB
33 way	TFH33CDSNB
34 way	TFH34CDSNB
35 way	TFH35CDSNB
36 way	TFH36CDSNB
37 way	TFH37CDSNB
38 way	TFH38CDSNB
39 way	TFH39CDSNB
40 way	TFH40CDSNB

#### Dimensions (mm)

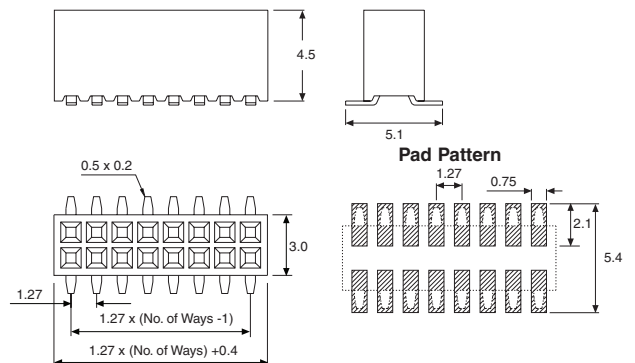

**Through Hole**

A range of straight, through hole mounting sockets on a 1.27mm pitch available in single and double row.

**SINGLE ROW**

Choice of 2 to 40 ways.

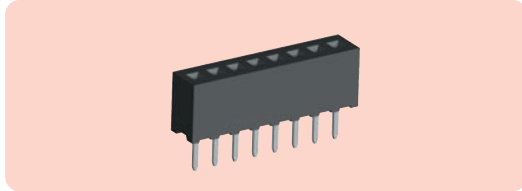

Type	Manf. Part No. & anglia Order Code
STRAIGHT	
2 way	TFH02CSS
3 way	TFH03CSS
4 way	TFH04CSS
5 way	TFH05CSS
6 way	TFH06CSS
7 way	TFH07CSS
8 way	TFH08CSS
9 way	TFH09CSS
10 way	TFH10CSS
11 way	TFH11CSS
12 way	TFH12CSS
13 way	TFH13CSS
14 way	TFH14CSS
15 way	TFH15CSS
16 way	TFH16CSS
17 way	TFH17CSS
18 way	TFH18CSS
19 way	TFH19CSS
20 way	TFH20CSS
21 way	TFH21CSS
22 way	TFH22CSS
23 way	TFH23CSS
24 way	TFH24CSS
25 way	TFH25CSS
26 way	TFH26CSS
27 way	TFH27CSS
28 way	TFH28CSS
29 way	TFH29CSS
30 way	TFH30CSS
31 way	TFH31CSS
32 way	TFH32CSS
33 way	TFH33CSS
34 way	TFH34CSS
35 way	TFH35CSS
36 way	TFH36CSS
37 way	TFH37CSS
38 way	TFH38CSS
39 way	TFH39CSS
40 way	TFH40CSS

**DOUBLE ROW**

Choice of 2 to 40 way (4 to 80 contacts).

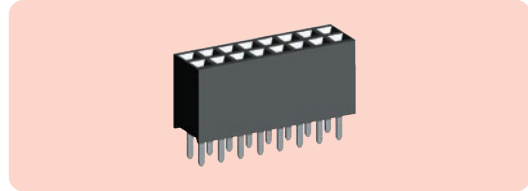

Type	Manf. Part No. & anglia Order Code
STRAIGHT	
2 way	TFH02CDS
3 way	TFH03CDS
4 way	TFH04CDS
5 way	TFH05CDS
6 way	TFH06CDS
7 way	TFH07CDS
8 way	TFH08CDS
9 way	TFH09CDS
10 way	TFH10CDS
11 way	TFH11CDS
12 way	TFH12CDS
13 way	TFH13CDS
14 way	TFH14CDS
15 way	TFH15CDS
16 way	TFH16CDS
17 way	TFH17CDS
18 way	TFH18CDS
19 way	TFH19CDS
20 way	TFH20CDS
21 way	TFH21CDS
22 way	TFH22CDS
23 way	TFH23CDS
24 way	TFH24CDS
25 way	TFH25CDS
26 way	TFH26CDS
27 way	TFH27CDS
28 way	TFH28CDS
29 way	TFH29CDS
30 way	TFH30CDS
31 way	TFH31CDS
32 way	TFH32CDS
33 way	TFH33CDS
34 way	TFH34CDS
35 way	TFH35CDS
36 way	TFH36CDS
37 way	TFH37CDS
38 way	TFH38CDS
39 way	TFH39CDS
40 way	TFH40CDS

**Dimensions (mm)**

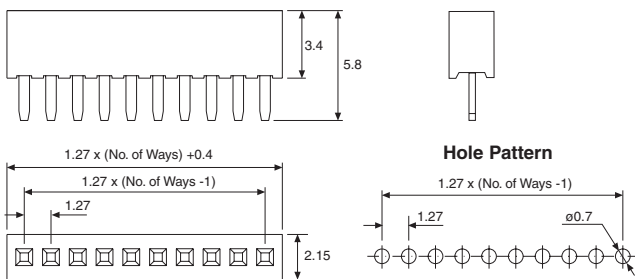

**Dimensions (mm)**

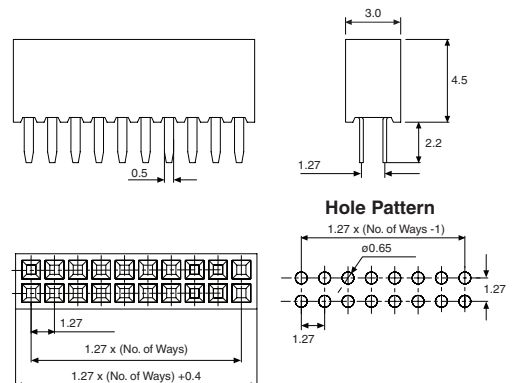

## Through Hole

### SINGLE ROW SOCKETS

A range of right angle, single row, through hole mounting sockets on a 1.27mm pitch. Choice of 2 to 40 ways.

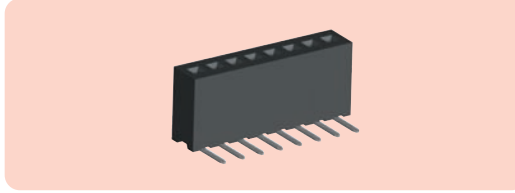

Type	Manf. Part No. & anglia Order Code	Type	Manf. Part No. & anglia Order Code
<b>RIGHT ANGLE</b>		<b>RIGHT ANGLE</b>	
2 way	TFH02CSR	21 way	TFH21CSR
3 way	TFH03CSR	22 way	TFH22CSR
4 way	TFH04CSR	23 way	TFH23CSR
5 way	TFH05CSR	24 way	TFH24CSR
6 way	TFH06CSR	25 way	TFH25CSR
7 way	TFH07CSR	26 way	TFH26CSR
8 way	TFH08CSR	27 way	TFH27CSR
9 way	TFH09CSR	28 way	TFH28CSR
10 way	TFH10CSR	29 way	TFH29CSR
11 way	TFH11CSR	30 way	TFH30CSR
12 way	TFH12CSR	31 way	TFH31CSR
13 way	TFH13CSR	32 way	TFH32CSR
14 way	TFH14CSR	33 way	TFH33CSR
15 way	TFH15CSR	34 way	TFH34CSR
16 way	TFH16CSR	35 way	TFH35CSR
17 way	TFH17CSR	36 way	TFH36CSR
18 way	TFH18CSR	37 way	TFH37CSR
19 way	TFH19CSR	38 way	TFH38CSR
20 way	TFH20CSR	39 way	TFH39CSR
		40 way	TFH40CSR

### Dimensions (mm)

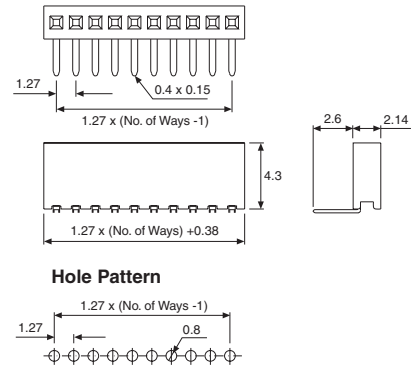

### MINI JUMPER LINKS

1.27mm pitch shorting links for use with the surface mount and through hole 0.4mm square pin headers shown on the previous pages. Contacts gold over nickel plated for higher reliability. Choice of type and colour with other colours available to special volume order. End and side stackable.

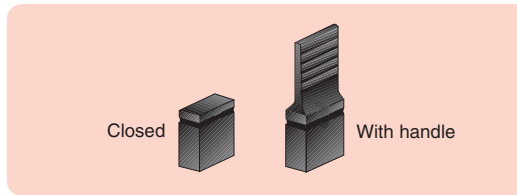

#### CLOSED TYPE

Fully covered link

**Colour**  
 Black  
 Red  
 Yellow  
 Green  
 Blue  
 White

Manf. Part No. & anglia Order Code
TMJC00C
TMJC02C
TMJC04C
TMJC05C
TMJC06C
TMJC09C

#### WITH HANDLE

For easier removal

**Colour**  
 Black  
 Red  
 Yellow  
 Green  
 Blue  
 White

Manf. Part No. & anglia Order Code
TMJC00H
TMJC02H
TMJC04H
TMJC05H
TMJC06H
TMJC09H

#### Dimensions (mm)

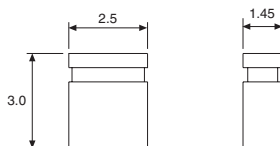

#### Dimensions (mm)

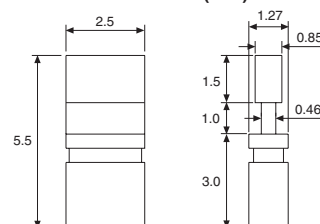



A range of double row pin headers on a 1.27 x 2.54mm pitch. Available in surface and through hole mounting, each offers straight versions with a right angle option in through hole.

**Surface Mount**

**DOUBLE ROW**

Choice of 2 to 40 ways (4 to 80 pins).

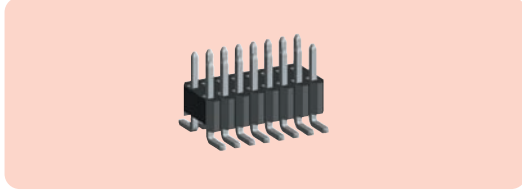

Type	Manf. Part No. & anglia Order Code
<b>STRAIGHT</b>	
2 way	TPH02EDSNB
3 way	TPH03EDSNB
4 way	TPH04EDSNB
5 way	TPH05EDSNB
6 way	TPH06EDSNB
7 way	TPH07EDSNB
8 way	TPH08EDSNB
9 way	TPH09EDSNB
10 way	TPH10EDSNB
11 way	TPH11EDSNB
12 way	TPH12EDSNB
13 way	TPH13EDSNB
14 way	TPH14EDSNB
15 way	TPH15EDSNB
16 way	TPH16EDSNB
17 way	TPH17EDSNB
18 way	TPH18EDSNB
19 way	TPH19EDSNB
20 way	TPH20EDSNB
21 way	TPH21EDSNB
22 way	TPH22EDSNB
23 way	TPH23EDSNB
24 way	TPH24EDSNB
25 way	TPH25EDSNB
26 way	TPH26EDSNB
27 way	TPH27EDSNB
28 way	TPH28EDSNB
29 way	TPH29EDSNB
30 way	TPH30EDSNB
31 way	TPH31EDSNB
32 way	TPH32EDSNB
33 way	TPH33EDSNB
34 way	TPH34EDSNB
35 way	TPH35EDSNB
36 way	TPH36EDSNB
37 way	TPH37EDSNB
38 way	TPH38EDSNB
39 way	TPH39EDSNB
40 way	TPH40EDSNB

**Dimensions (mm)**

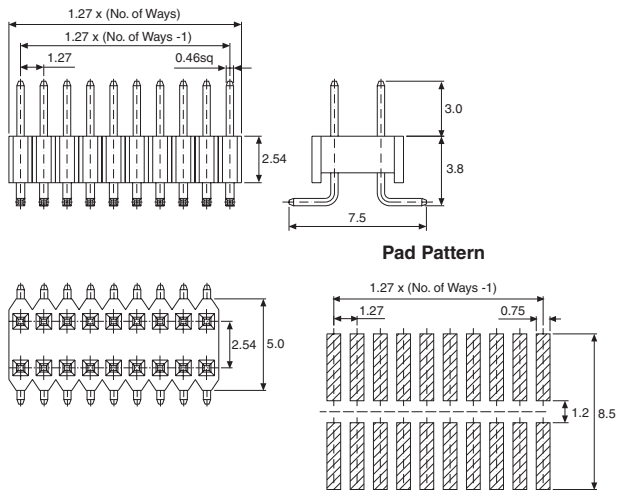

**Through Hole**

**DOUBLE ROW**

Choice of 2 to 40 ways (4 to 80 pins) with straight or r/angle option.

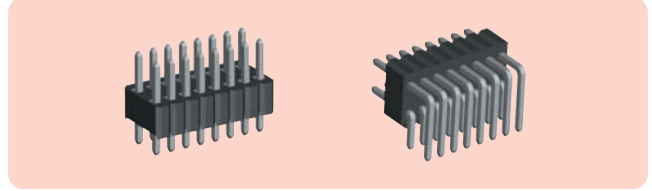

Type	Manf. Part No. & anglia Order Code	Manf. Part No. & anglia Order Code
<b>STRAIGHT</b>		<b>RIGHT ANGLE</b>
2 way	TPH02EDS	TPH02EDR
3 way	TPH03EDS	TPH03EDR
4 way	TPH04EDS	TPH04EDR
5 way	TPH05EDS	TPH05EDR
6 way	TPH06EDS	TPH06EDR
7 way	TPH07EDS	TPH07EDR
8 way	TPH08EDS	TPH08EDR
9 way	TPH09EDS	TPH09EDR
10 way	TPH10EDS	TPH10EDR
11 way	TPH11EDS	TPH11EDR
12 way	TPH12EDS	TPH12EDR
13 way	TPH13EDS	TPH13EDR
14 way	TPH14EDS	TPH14EDR
15 way	TPH15EDS	TPH15EDR
16 way	TPH16EDS	TPH16EDR
17 way	TPH17EDS	TPH17EDR
18 way	TPH18EDS	TPH18EDR
19 way	TPH19EDS	TPH19EDR
20 way	TPH20EDS	TPH20EDR
21 way	TPH21EDS	TPH21EDR
22 way	TPH22EDS	TPH22EDR
23 way	TPH23EDS	TPH23EDR
24 way	TPH24EDS	TPH24EDR
25 way	TPH25EDS	TPH25EDR
26 way	TPH26EDS	TPH26EDR
27 way	TPH27EDS	TPH27EDR
28 way	TPH28EDS	TPH28EDR
29 way	TPH29EDS	TPH29EDR
30 way	TPH30EDS	TPH30EDR
31 way	TPH31EDS	TPH31EDR
32 way	TPH32EDS	TPH32EDR
33 way	TPH33EDS	TPH33EDR
34 way	TPH34EDS	TPH34EDR
35 way	TPH35EDS	TPH35EDR
36 way	TPH36EDS	TPH36EDR
37 way	TPH37EDS	TPH37EDR
38 way	TPH38EDS	TPH38EDR
39 way	TPH39EDS	TPH39EDR
40 way	TPH40EDS	TPH40EDR

**Dimensions (mm)**

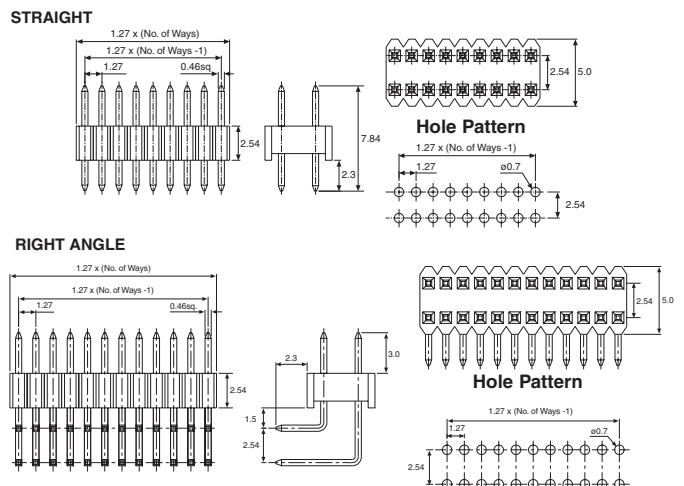

A range of double row straight sockets on a 1.27 x 2.54mm pitch available in surface and through hole mounting.

### Surface Mount

### Through Hole

#### DOUBLE ROW

Choice of 2 to 40 ways (4 to 80 contacts).

#### DOUBLE ROW

Choice of 2 to 40 ways (4 to 80 contacts).

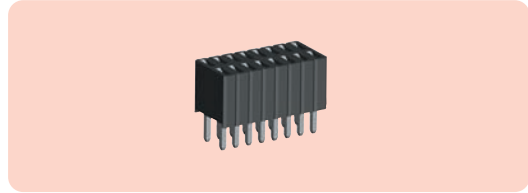
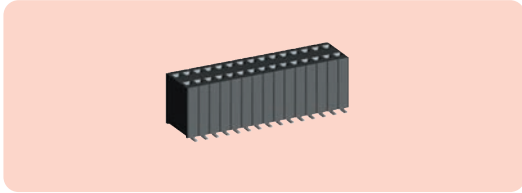

Type	Manf. Part No. & anglia Order Code
<b>STRAIGHT</b>	
3 way	TFH03EDSNB
4 way	TFH04EDSNB
5 way	TFH05EDSNB
6 way	TFH06EDSNB
7 way	TFH07EDSNB
8 way	TFH08EDSNB
9 way	TFH09EDSNB
10 way	TFH10EDSNB
11 way	TFH11EDSNB
12 way	TFH12EDSNB
13 way	TFH13EDSNB
14 way	TFH14EDSNB
15 way	TFH15EDSNB
16 way	TFH16EDSNB
17 way	TFH17EDSNB
18 way	TFH18EDSNB
19 way	TFH19EDSNB
20 way	TFH20EDSNB
21 way	TFH21EDSNB
22 way	TFH22EDSNB
23 way	TFH23EDSNB
24 way	TFH24EDSNB
25 way	TFH25EDSNB
26 way	TFH26EDSNB
27 way	TFH27EDSNB
28 way	TFH28EDSNB
29 way	TFH29EDSNB
30 way	TFH30EDSNB
31 way	TFH31EDSNB
32 way	TFH32EDSNB
33 way	TFH33EDSNB
34 way	TFH34EDSNB
35 way	TFH35EDSNB
36 way	TFH36EDSNB
37 way	TFH37EDSNB
38 way	TFH38EDSNB
39 way	TFH39EDSNB
40 way	TFH40EDSNB

Type	Manf. Part No. & anglia Order Code
<b>STRAIGHT</b>	
2 way	TFH02EDS
3 way	TFH03EDS
4 way	TFH04EDS
5 way	TFH05EDS
6 way	TFH06EDS
7 way	TFH07EDS
8 way	TFH08EDS
9 way	TFH09EDS
10 way	TFH10EDS
11 way	TFH11EDS
12 way	TFH12EDS
13 way	TFH13EDS
14 way	TFH14EDS
15 way	TFH15EDS
16 way	TFH16EDS
17 way	TFH17EDS
18 way	TFH18EDS
19 way	TFH19EDS
20 way	TFH20EDS
21 way	TFH21EDS
22 way	TFH22EDS
23 way	TFH23EDS
24 way	TFH24EDS
25 way	TFH25EDS
26 way	TFH26EDS
27 way	TFH27EDS
28 way	TFH28EDS
29 way	TFH29EDS
30 way	TFH30EDS
31 way	TFH31EDS
32 way	TFH32EDS
33 way	TFH33EDS
34 way	TFH34EDS
35 way	TFH35EDS
36 way	TFH36EDS
37 way	TFH37EDS
38 way	TFH38EDS
39 way	TFH39EDS
40 way	TFH40EDS

#### Dimensions (mm)

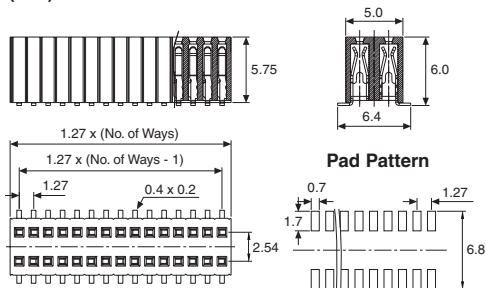

#### Dimensions (mm)

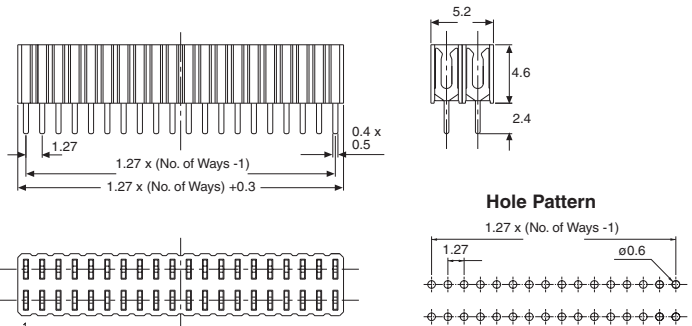

Single Row available to special order

**Surface Mount**

A range of straight, surface mounting pin headers on a 2.0mm pitch available in single and double row.

**SINGLE ROW**

Choice of 3 to 40 ways.

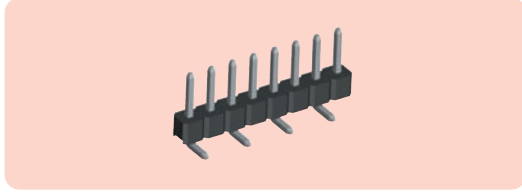

Type	Manf. Part No. & anglia Order Code
<b>STRAIGHT</b>	
3 way	TPH03BSSNB
4 way	TPH04BSSNB
5 way	TPH05BSSNB
6 way	TPH06BSSNB
7 way	TPH07BSSNB
8 way	TPH08BSSNB
9 way	TPH09BSSNB
10 way	TPH10BSSNB
11 way	TPH11BSSNB
12 way	TPH12BSSNB
13 way	TPH13BSSNB
14 way	TPH14BSSNB
15 way	TPH15BSSNB
16 way	TPH16BSSNB
17 way	TPH17BSSNB
18 way	TPH18BSSNB
19 way	TPH19BSSNB
20 way	TPH20BSSNB
21 way	TPH21BSSNB
22 way	TPH22BSSNB
23 way	TPH23BSSNB
24 way	TPH24BSSNB
25 way	TPH25BSSNB
26 way	TPH26BSSNB
27 way	TPH27BSSNB
28 way	TPH28BSSNB
29 way	TPH29BSSNB
30 way	TPH30BSSNB
31 way	TPH31BSSNB
32 way	TPH32BSSNB
33 way	TPH33BSSNB
34 way	TPH34BSSNB
35 way	TPH35BSSNB
36 way	TPH36BSSNB
37 way	TPH37BSSNB
38 way	TPH38BSSNB
39 way	TPH39BSSNB
40 way	TPH40BSSNB

**DOUBLE ROW**

Choice of 2 to 40 ways (4 to 80 pins).

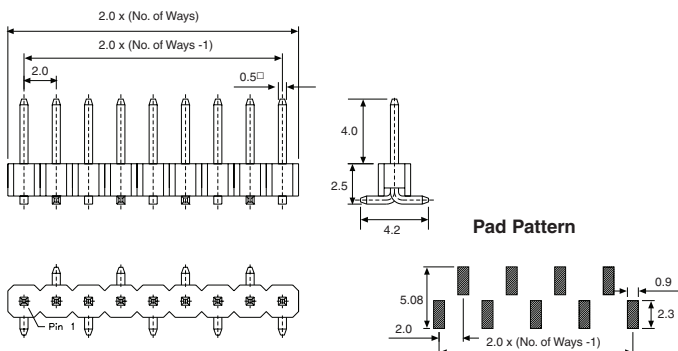
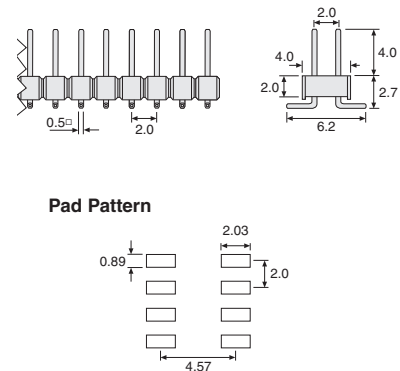

Type	Manf. Part No. & anglia Order Code
<b>STRAIGHT</b>	
2 way	TPH02BDSSM
3 way	TPH03BDSSM
4 way	TPH04BDSSM
5 way	TPH05BDSSM
6 way	TPH06BDSSM
7 way	TPH07BDSSM
8 way	TPH08BDSSM
9 way	TPH09BDSSM
10 way	TPH10BDSSM
11 way	TPH11BDSSM
12 way	TPH12BDSSM
13 way	TPH13BDSSM
14 way	TPH14BDSSM
15 way	TPH15BDSSM
16 way	TPH16BDSSM
17 way	TPH17BDSSM
18 way	TPH18BDSSM
19 way	TPH19BDSSM
20 way	TPH20BDSSM
21 way	TPH21BDSSM
22 way	TPH22BDSSM
23 way	TPH23BDSSM
24 way	TPH24BDSSM
25 way	TPH25BDSSM
26 way	TPH26BDSSM
27 way	TPH27BDSSM
28 way	TPH28BDSSM
29 way	TPH29BDSSM
30 way	TPH30BDSSM
31 way	TPH31BDSSM
32 way	TPH32BDSSM
33 way	TPH33BDSSM
34 way	TPH34BDSSM
35 way	TPH35BDSSM
36 way	TPH36BDSSM
37 way	TPH37BDSSM
38 way	TPH38BDSSM
39 way	TPH39BDSSM
40 way	TPH40BDSSM

**Dimensions (mm)**

**Dimensions (mm)**

### Through Hole

A range of straight and right angle, through hole mounting pin headers on a 2.0mm pitch available in single and double row.

#### SINGLE ROW

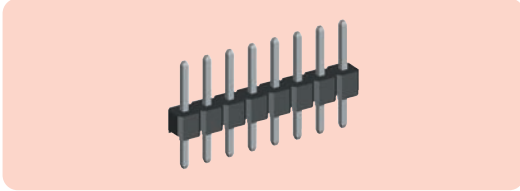
Choice of 2 to 40 ways in both straight and right angle.



Type	Manf. Part No. & anglia Order Code
STRAIGHT	2 way <i>TPH02BSS</i>
	3 way <i>TPH03BSS</i>
	4 way <i>TPH04BSS</i>
	5 way <i>TPH05BSS</i>
	6 way <i>TPH06BSS</i>
	8 way <i>TPH08BSS</i>
	10 way <i>TPH10BSS</i>
	12 way <i>TPH12BSS</i>
	18 way <i>TPH18BSS</i>
	20 way <i>TPH20BSS</i>
	25 way <i>TPH25BSS</i>
	40 way <i>TPH40BSS</i>

Dimensions (mm)

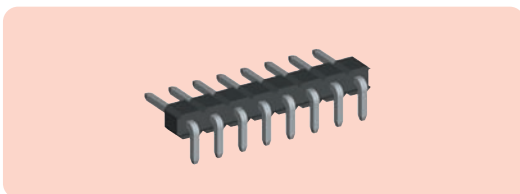
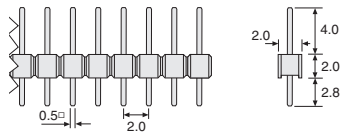

Type	Manf. Part No. & anglia Order Code
RIGHT ANGLE	2 way <i>TPH02BSR</i>
	3 way <i>TPH03BSR</i>
	4 way <i>TPH04BSR</i>
	5 way <i>TPH05BSR</i>
	6 way <i>TPH06BSR</i>
	8 way <i>TPH08BSR</i>
	10 way <i>TPH10BSR</i>
	12 way <i>TPH12BSR</i>
	20 way <i>TPH20BSR</i>
	25 way <i>TPH25BSR</i>
	40 way <i>TPH40BSR</i>

Dimensions (mm)

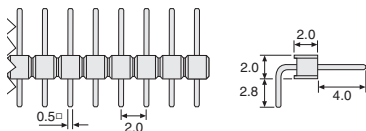

#### DOUBLE ROW

Choice of 2 to 40 ways (4 to 80 pins) in both straight and r/angle.

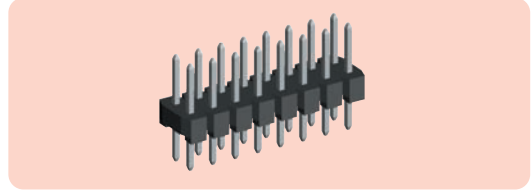

Type	Manf. Part No. & anglia Order Code
STRAIGHT	2 way <i>TPH02BDS</i>
	3 way <i>TPH03BDS</i>
	4 way <i>TPH04BDS</i>
	5 way <i>TPH05BDS</i>
	6 way <i>TPH06BDS</i>
	8 way <i>TPH08BDS</i>
	10 way <i>TPH10BDS</i>
	12 way <i>TPH12BDS</i>
	20 way <i>TPH20BDS</i>
	25 way <i>TPH25BDS</i>
	40 way <i>TPH40BDS</i>

Dimensions (mm)

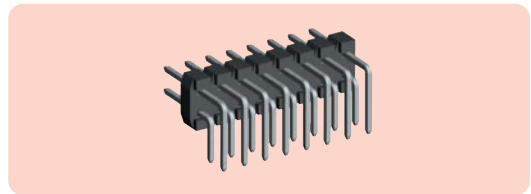
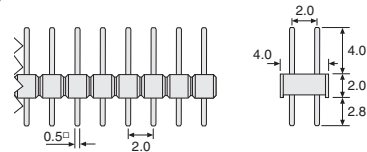

Type	Manf. Part No. & anglia Order Code
RIGHT ANGLE	2 way <i>TPH02BDR</i>
	3 way <i>TPH03BDR</i>
	4 way <i>TPH04BDR</i>
	5 way <i>TPH05BDR</i>
	6 way <i>TPH06BDR</i>
	8 way <i>TPH08BDR</i>
	10 way <i>TPH10BDR</i>
	12 way <i>TPH12BDR</i>
	20 way <i>TPH20BDR</i>
	25 way <i>TPH25BDR</i>
	40 way <i>TPH40BDR</i>

Dimensions (mm)

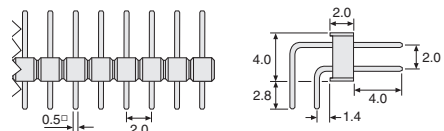

Other ways available to special order

**Surface Mount**

A range of straight, surface mounting sockets on a 2.0mm pitch available in single and double row.

**SINGLE ROW**

Choice of 2 to 40 ways.

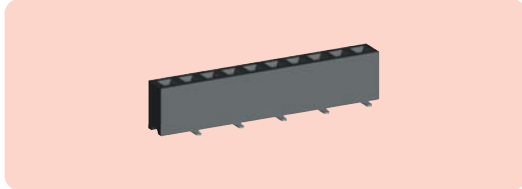

**DOUBLE ROW**

Choice of 4 to 40 ways (8 to 80 contacts).

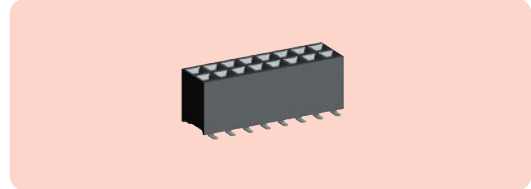

Type	Manf. Part No. & anglia Order Code
STRAIGHT	
2 way	TFH02BSSNB
3 way	TFH03BSSNB
4 way	TFH04BSSNB
5 way	TFH05BSSNB
6 way	TFH06BSSNB
7 way	TFH07BSSNB
8 way	TFH08BSSNB
9 way	TFH09BSSNB
10 way	TFH10BSSNB
11 way	TFH11BSSNB
12 way	TFH12BSSNB
13 way	TFH13BSSNB
14 way	TFH14BSSNB
15 way	TFH15BSSNB
16 way	TFH16BSSNB
17 way	TFH17BSSNB
18 way	TFH18BSSNB
19 way	TFH19BSSNB
20 way	TFH20BSSNB

Type	Manf. Part No. & anglia Order Code
STRAIGHT	
21 way	TFH21BSSNB
22 way	TFH22BSSNB
23 way	TFH23BSSNB
24 way	TFH24BSSNB
25 way	TFH25BSSNB
26 way	TFH26BSSNB
27 way	TFH27BSSNB
28 way	TFH28BSSNB
29 way	TFH29BSSNB
30 way	TFH30BSSNB
31 way	TFH31BSSNB
32 way	TFH32BSSNB
33 way	TFH33BSSNB
34 way	TFH34BSSNB
35 way	TFH35BSSNB
36 way	TFH36BSSNB
37 way	TFH37BSSNB
38 way	TFH38BSSNB
39 way	TFH39BSSNB
40 way	TFH40BSSNB

Type	Manf. Part No. & anglia Order Code
STRAIGHT	
3 way	TFH03BDSSM
4 way	TFH04BDSSM
5 way	TFH05BDSSM
6 way	TFH06BDSSM
7 way	TFH07BDSSM
8 way	TFH08BDSSM
9 way	TFH09BDSSM
10 way	TFH10BDSSM
11 way	TFH11BDSSM
12 way	TFH12BDSSM
13 way	TFH13BDSSM
14 way	TFH14BDSSM
15 way	TFH15BDSSM
16 way	TFH16BDSSM
17 way	TFH17BDSSM
18 way	TFH18BDSSM
19 way	TFH19BDSSM
20 way	TFH20BDSSM

Type	Manf. Part No. & anglia Order Code
STRAIGHT	
21 way	TFH21BDSSM
22 way	TFH22BDSSM
23 way	TFH23BDSSM
24 way	TFH24BDSSM
25 way	TFH25BDSSM
26 way	TFH26BDSSM
27 way	TFH27BDSSM
28 way	TFH28BDSSM
29 way	TFH29BDSSM
30 way	TFH30BDSSM
31 way	TFH31BDSSM
32 way	TFH32BDSSM
33 way	TFH33BDSSM
34 way	TFH34BDSSM
35 way	TFH35BDSSM
36 way	TFH36BDSSM
37 way	TFH37BDSSM
38 way	TFH38BDSSM
39 way	TFH39BDSSM
40 way	TFH40BDSSM

**Dimensions (mm)**

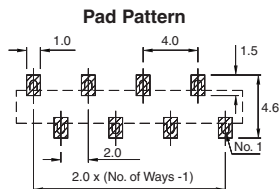
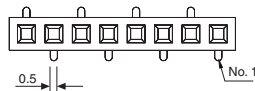
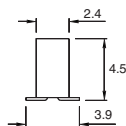
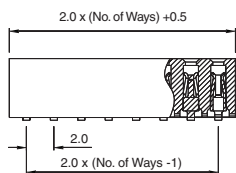

**Dimensions (mm)**

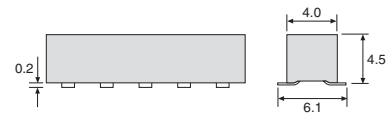
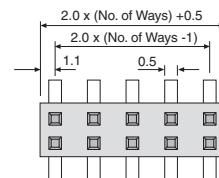

**Pad Pattern**

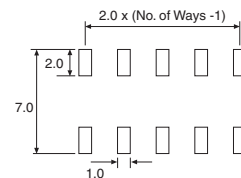

### Through Hole

#### SOCKETS

A range of straight, through hole mounting sockets on a 2.0mm pitch available in single and double row.

#### SINGLE ROW

Choice of 3 to 40 ways.

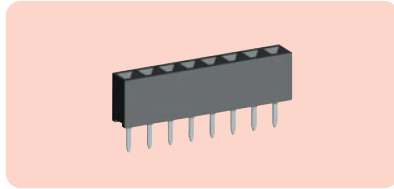

Type	Manf. Part No. & anglia Order Code	Type	Manf. Part No. & anglia Order Code
<b>STRAIGHT</b>		<b>STRAIGHT</b>	
3 way	TFH03BSS	21 way	TFH21BSS
4 way	TFH04BSS	22 way	TFH22BSS
5 way	TFH05BSS	23 way	TFH23BSS
6 way	TFH06BSS	24 way	TFH24BSS
7 way	TFH07BSS	25 way	TFH25BSS
8 way	TFH08BSS	26 way	TFH26BSS
9 way	TFH09BSS	27 way	TFH27BSS
10 way	TFH10BSS	28 way	TFH28BSS
11 way	TFH11BSS	29 way	TFH29BSS
12 way	TFH12BSS	30 way	TFH30BSS
13 way	TFH13BSS	31 way	TFH31BSS
14 way	TFH14BSS	32 way	TFH32BSS
15 way	TFH15BSS	33 way	TFH33BSS
16 way	TFH16BSS	34 way	TFH34BSS
17 way	TFH17BSS	35 way	TFH35BSS
18 way	TFH18BSS	36 way	TFH36BSS
19 way	TFH19BSS	37 way	TFH37BSS
20 way	TFH20BSS	38 way	TFH38BSS
		39 way	TFH39BSS
		40 way	TFH40BSS

#### Dimensions (mm)

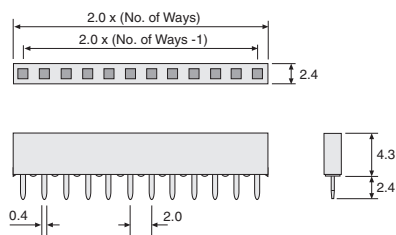

#### DOUBLE ROW

Choice of 3 to 40 ways (6 to 80 contacts).

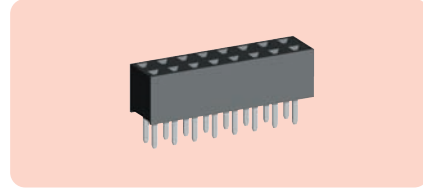

Type	Manf. Part No. & anglia Order Code	Type	Manf. Part No. & anglia Order Code
<b>STRAIGHT</b>		<b>STRAIGHT</b>	
3 way	TFH03BDS	21 way	TFH21BDS
4 way	TFH04BDS	22 way	TFH22BDS
5 way	TFH05BDS	23 way	TFH23BDS
6 way	TFH06BDS	24 way	TFH24BDS
7 way	TFH07BDS	25 way	TFH25BDS
8 way	TFH08BDS	26 way	TFH26BDS
9 way	TFH09BDS	27 way	TFH27BDS
10 way	TFH10BDS	28 way	TFH28BDS
11 way	TFH11BDS	29 way	TFH29BDS
12 way	TFH12BDS	30 way	TFH30BDS
13 way	TFH13BDS	31 way	TFH31BDS
14 way	TFH14BDS	32 way	TFH32BDS
15 way	TFH15BDS	33 way	TFH33BDS
16 way	TFH16BDS	34 way	TFH34BDS
17 way	TFH17BDS	35 way	TFH35BDS
18 way	TFH18BDS	36 way	TFH36BDS
19 way	TFH19BDS	37 way	TFH37BDS
20 way	TFH20BDS	38 way	TFH38BDS
		39 way	TFH39BDS
		40 way	TFH40BDS

#### Dimensions (mm)

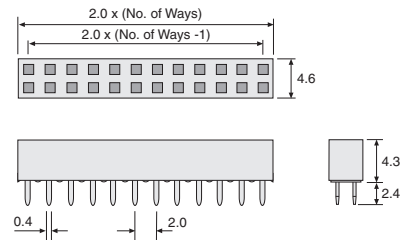

#### MINI JUMPER LINKS

2.0mm pitch shorting links for use with the surface mount and through hole 0.5mm square pin headers shown on the previous pages. Contacts gold over nickel plated for higher reliability. Choice of open or closed type. Colour black. End and side stackable.

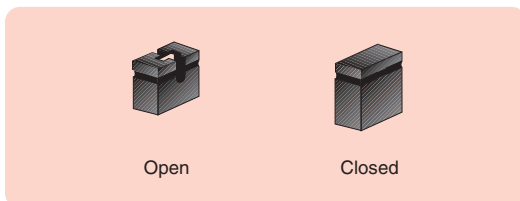

Open

Closed

#### OPEN TYPE

Allows test probe access.

Manf. Part No. & anglia Order Code  
**TMJ00B**

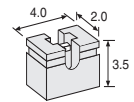

Dimensions (mm)

#### CLOSED TYPE

Fully covered link.

Manf. Part No. & anglia Order Code  
**TMJ00BC**

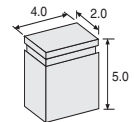

**Through Hole**

A range of right angle, through hole mounting sockets on a 2.0mm pitch available in single and double row.

**SINGLE ROW**

Choice of 2 to 40 ways.

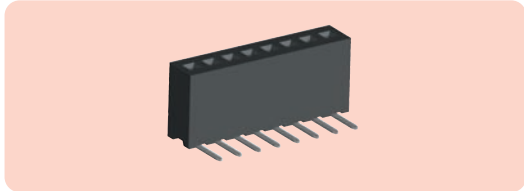

**DOUBLE ROW**

Choice of 2 to 40 ways (4 to 80 contacts).

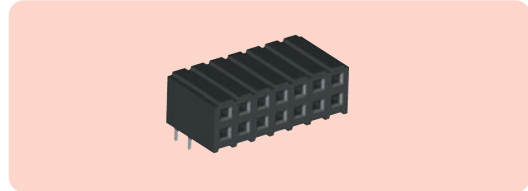

Type	Manf. Part No. & Anglia Order Code	Type	Manf. Part No. & Anglia Order Code
<b>RIGHT ANGLE</b>		<b>RIGHT ANGLE</b>	
2 way	TFH02BSR	21 way	TFH21BSR
3 way	TFH03BSR	22 way	TFH22BSR
4 way	TFH04BSR	23 way	TFH23BSR
5 way	TFH05BSR	24 way	TFH24BSR
6 way	TFH06BSR	25 way	TFH25BSR
7 way	TFH07BSR	26 way	TFH26BSR
8 way	TFH08BSR	27 way	TFH27BSR
9 way	TFH09BSR	28 way	TFH28BSR
10 way	TFH10BSR	29 way	TFH29BSR
11 way	TFH11BSR	30 way	TFH30BSR
12 way	TFH12BSR	31 way	TFH31BSR
13 way	TFH13BSR	32 way	TFH32BSR
14 way	TFH14BSR	33 way	TFH33BSR
15 way	TFH15BSR	34 way	TFH34BSR
16 way	TFH16BSR	35 way	TFH35BSR
17 way	TFH17BSR	36 way	TFH36BSR
18 way	TFH18BSR	37 way	TFH37BSR
19 way	TFH19BSR	38 way	TFH38BSR
20 way	TFH20BSR	39 way	TFH39BSR
		40 way	TFH40BSR

Type	Manf. Part No. & Anglia Order Code	Type	Manf. Part No. & Anglia Order Code
<b>RIGHT ANGLE</b>		<b>RIGHT ANGLE</b>	
2 way	TFH02BDR	21 way	TFH21BDR
3 way	TFH03BDR	22 way	TFH22BDR
4 way	TFH04BDR	23 way	TFH23BDR
5 way	TFH05BDR	24 way	TFH24BDR
6 way	TFH06BDR	25 way	TFH25BDR
7 way	TFH07BDR	26 way	TFH26BDR
8 way	TFH08BDR	27 way	TFH27BDR
9 way	TFH09BDR	28 way	TFH28BDR
10 way	TFH10BDR	29 way	TFH29BDR
11 way	TFH11BDR	30 way	TFH30BDR
12 way	TFH12BDR	31 way	TFH31BDR
13 way	TFH13BDR	32 way	TFH32BDR
14 way	TFH14BDR	33 way	TFH33BDR
15 way	TFH15BDR	34 way	TFH34BDR
16 way	TFH16BDR	35 way	TFH35BDR
17 way	TFH17BDR	36 way	TFH36BDR
18 way	TFH18BDR	37 way	TFH37BDR
19 way	TFH19BDR	38 way	TFH38BDR
20 way	TFH20BDR	39 way	TFH39BDR
		40 way	TFH40BDR

Dimensions (mm)

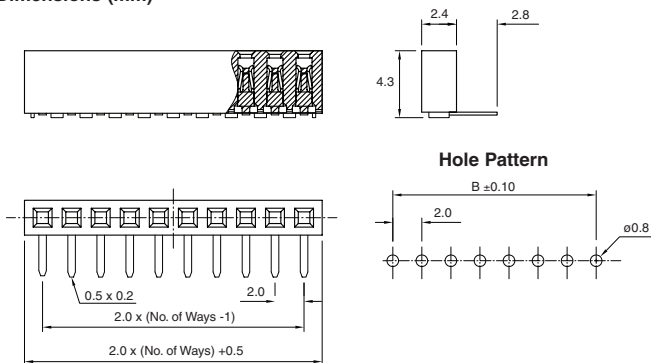

Dimensions (mm)

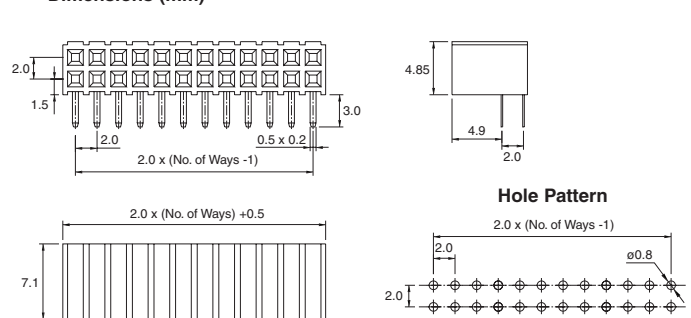

**TAICOM**

For the very latest information and news on the full range of TAICOM products available from Anglia, visit our website : [www.anglia.com/taicom](http://www.anglia.com/taicom)

Alternatively, contact our Sales Desk to discuss your specific requirements.

## Surface Mount

A range of straight, surface mounting pin headers on a 2.54mm pitch available in single and double row.

### SINGLE ROW

Choice of 2 to 40 ways.



Type	Manf. Part No. & anglia Order Code
<b>STRAIGHT</b>	
2 way	TPH02SSNB
3 way	TPH03SSNB
4 way	TPH04SSNB
5 way	TPH05SSNB
6 way	TPH06SSNB
7 way	TPH07SSNB
8 way	TPH08SSNB
9 way	TPH09SSNB
10 way	TPH10SSNB
11 way	TPH11SSNB
12 way	TPH12SSNB
13 way	TPH13SSNB
14 way	TPH14SSNB
15 way	TPH15SSNB
16 way	TPH16SSNB
17 way	TPH17SSNB
18 way	TPH18SSNB
19 way	TPH19SSNB
20 way	TPH20SSNB
21 way	TPH21SSNB
22 way	TPH22SSNB
23 way	TPH23SSNB
24 way	TPH24SSNB
25 way	TPH25SSNB
26 way	TPH26SSNB
27 way	TPH27SSNB
28 way	TPH28SSNB
29 way	TPH29SSNB
30 way	TPH30SSNB
31 way	TPH31SSNB
32 way	TPH32SSNB
33 way	TPH33SSNB
34 way	TPH34SSNB
35 way	TPH35SSNB
36 way	TPH36SSNB
37 way	TPH37SSNB
38 way	TPH38SSNB
39 way	TPH39SSNB
40 way	TPH40SSNB

### Dimensions (mm)

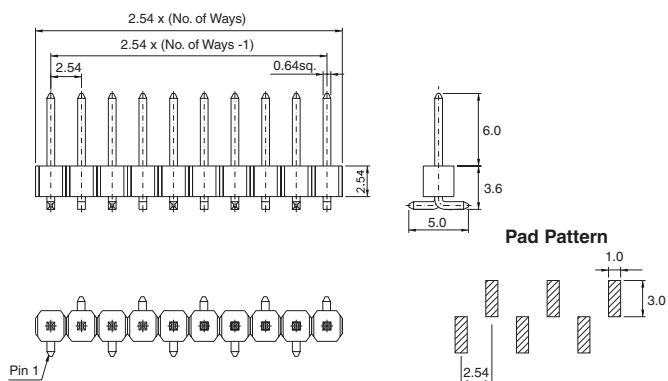

### DOUBLE ROW

Choice of 2 to 40 ways (4 to 80 pins).

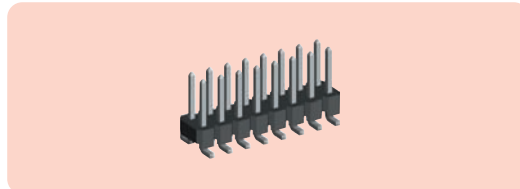

Type	Manf. Part No. & anglia Order Code
<b>STRAIGHT</b>	
2 way	TPH02DSNB
3 way	TPH03DSNB
4 way	TPH04DSNB
5 way	TPH05DSNB
6 way	TPH06DSNB
7 way	TPH07DSNB
8 way	TPH08DSNB
9 way	TPH09DSNB
10 way	TPH10DSNB
11 way	TPH11DSNB
12 way	TPH12DSNB
13 way	TPH13DSNB
14 way	TPH14DSNB
15 way	TPH15DSNB
16 way	TPH16DSNB
17 way	TPH17DSNB
18 way	TPH18DSNB
19 way	TPH19DSNB
20 way	TPH20DSNB
21 way	TPH21DSNB
22 way	TPH22DSNB
23 way	TPH23DSNB
24 way	TPH24DSNB
25 way	TPH25DSNB
26 way	TPH26DSNB
27 way	TPH27DSNB
28 way	TPH28DSNB
29 way	TPH29DSNB
30 way	TPH30DSNB
31 way	TPH31DSNB
32 way	TPH32DSNB
33 way	TPH33DSNB
34 way	TPH34DSNB
35 way	TPH35DSNB
36 way	TPH36DSNB
37 way	TPH37DSNB
38 way	TPH38DSNB
39 way	TPH39DSNB
40 way	TPH40DSNB

### Dimensions (mm)

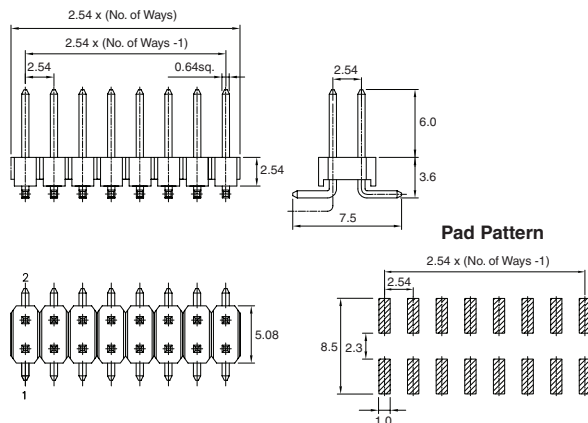



**Through Hole**

A range of straight, through hole mounting pin headers on a 2.54mm pitch available in single and double row.

**SINGLE ROW**

Choice of 2 to 40 ways.

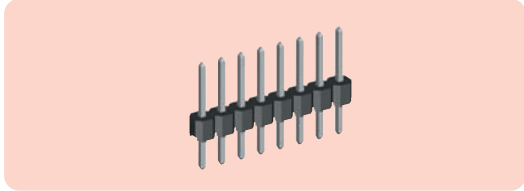

Type	Manf. Part No. & anglia Order Code
STRAIGHT	
2 way	TPH02SS
3 way	TPH03SS
4 way	TPH04SS
5 way	TPH05SS
6 way	TPH06SS
7 way	TPH07SS
8 way	TPH08SS
9 way	TPH09SS
10 way	TPH10SS
11 way	TPH11SS
12 way	TPH12SS
13 way	TPH13SS
14 way	TPH14SS
15 way	TPH15SS
16 way	TPH16SS
17 way	TPH17SS
18 way	TPH18SS
19 way	TPH19SS
20 way	TPH20SS
21 way	TPH21SS
22 way	TPH22SS
23 way	TPH23SS
24 way	TPH24SS
25 way	TPH25SS
26 way	TPH26SS
27 way	TPH27SS
28 way	TPH28SS
29 way	TPH29SS
30 way	TPH30SS
31 way	TPH31SS
32 way	TPH32SS
33 way	TPH33SS
34 way	TPH34SS
35 way	TPH35SS
36 way	TPH36SS
37 way	TPH37SS
38 way	TPH38SS
39 way	TPH39SS
40 way	TPH40SS

Dimensions (mm)

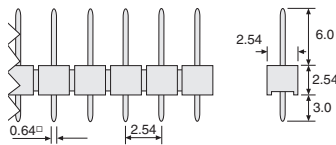

**DOUBLE ROW**

Choice of 2 to 40 ways (4 to 80 pins).

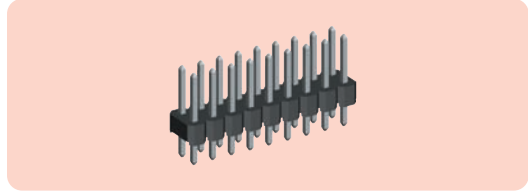

Type	Manf. Part No. & anglia Order Code
STRAIGHT	
2 way	TPH02DS
3 way	TPH03DS
4 way	TPH04DS
5 way	TPH05DS
6 way	TPH06DS
7 way	TPH07DS
8 way	TPH08DS
9 way	TPH09DS
10 way	TPH10DS
11 way	TPH11DS
12 way	TPH12DS
13 way	TPH13DS
14 way	TPH14DS
15 way	TPH15DS
16 way	TPH16DS
17 way	TPH17DS
18 way	TPH18DS
19 way	TPH19DS
20 way	TPH20DS
21 way	TPH21DS
22 way	TPH22DS
23 way	TPH23DS
24 way	TPH24DS
25 way	TPH25DS
26 way	TPH26DS
27 way	TPH27DS
28 way	TPH28DS
29 way	TPH29DS
30 way	TPH30DS
31 way	TPH31DS
32 way	TPH32DS
33 way	TPH33DS
34 way	TPH34DS
35 way	TPH35DS
36 way	TPH36DS
37 way	TPH37DS
38 way	TPH38DS
39 way	TPH39DS
40 way	TPH40DS

Dimensions (mm)

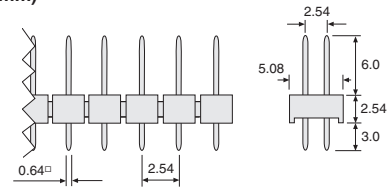

## Through Hole

A range of right angle, through hole mounting pin headers on a 2.54mm pitch available in single and double row.

### SINGLE ROW

Choice of 2 to 40 ways with option of flush or standard pin position.

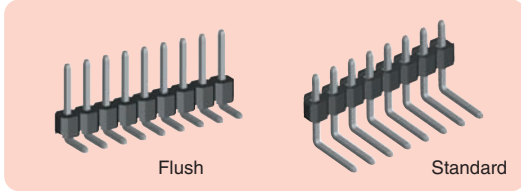

### DOUBLE ROW

Choice of 2 to 40 ways (4 to 80 pins).

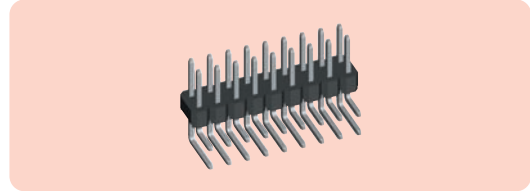

Type	Manf. Part No. & anglia Order Code	Type	Manf. Part No. & anglia Order Code
<b>R/ANGLE (Flush)</b>		<b>R/ANGLE (Std)</b>	
2 way	TPH02SRF	2 way	TPH02SR
3 way	TPH03SRF	3 way	TPH03SR
4 way	TPH04SRF	4 way	TPH04SR
5 way	TPH05SRF	5 way	TPH05SR
6 way	TPH06SRF	6 way	TPH06SR
7 way	TPH07SRF	7 way	TPH07SR
8 way	TPH08SRF	8 way	TPH08SR
9 way	TPH09SRF	9 way	TPH09SR
10 way	TPH10SRF	10 way	TPH10SR
11 way	TPH11SRF	11 way	TPH11SR
12 way	TPH12SRF	12 way	TPH12SR
13 way	TPH13SRF	13 way	TPH13SR
14 way	TPH14SRF	14 way	TPH14SR
15 way	TPH15SRF	15 way	TPH15SR
16 way	TPH16SRF	16 way	TPH16SR
17 way	TPH17SRF	17 way	TPH17SR
18 way	TPH18SRF	18 way	TPH18SR
19 way	TPH19SRF	19 way	TPH19SR
20 way	TPH20SRF	20 way	TPH20SR
21 way	TPH21SRF	21 way	TPH21SR
22 way	TPH22SRF	22 way	TPH22SR
23 way	TPH23SRF	23 way	TPH23SR
24 way	TPH24SRF	24 way	TPH24SR
25 way	TPH25SRF	25 way	TPH25SR
26 way	TPH26SRF	26 way	TPH26SR
27 way	TPH27SRF	27 way	TPH27SR
28 way	TPH28SRF	28 way	TPH28SR
29 way	TPH29SRF	29 way	TPH29SR
30 way	TPH30SRF	30 way	TPH30SR
31 way	TPH31SRF	31 way	TPH31SR
32 way	TPH32SRF	32 way	TPH32SR
33 way	TPH33SRF	33 way	TPH33SR
34 way	TPH34SRF	34 way	TPH34SR
35 way	TPH35SRF	35 way	TPH35SR
36 way	TPH36SRF	36 way	TPH36SR
37 way	TPH37SRF	37 way	TPH37SR
38 way	TPH38SRF	38 way	TPH38SR
39 way	TPH39SRF	39 way	TPH39SR
40 way	TPH40SRF	40 way	TPH40SR

Type	Manf. Part No. & anglia Order Code
<b>RIGHT ANGLE</b>	
2 way	TPH02DR
3 way	TPH03DR
4 way	TPH04DR
5 way	TPH05DR
6 way	TPH06DR
7 way	TPH07DR
8 way	TPH08DR
9 way	TPH09DR
10 way	TPH10DR
11 way	TPH11DR
12 way	TPH12DR
13 way	TPH13DR
14 way	TPH14DR
15 way	TPH15DR
16 way	TPH16DR
17 way	TPH17DR
18 way	TPH18DR
19 way	TPH19DR
20 way	TPH20DR
21 way	TPH21DR
22 way	TPH22DR
23 way	TPH23DR
24 way	TPH24DR
25 way	TPH25DR
26 way	TPH26DR
27 way	TPH27DR
28 way	TPH28DR
29 way	TPH29DR
30 way	TPH30DR
31 way	TPH31DR
32 way	TPH32DR
33 way	TPH33DR
34 way	TPH34DR
35 way	TPH35DR
36 way	TPH36DR
37 way	TPH37DR
38 way	TPH38DR
39 way	TPH39DR
40 way	TPH40DR

### Dimensions (mm)

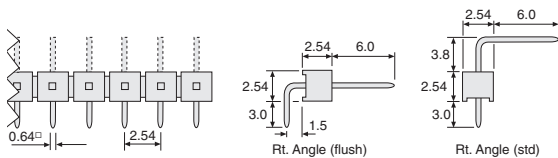

### Dimensions (mm)

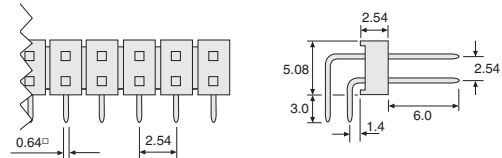

**Surface Mount**

A range of straight, surface mounting sockets on a 2.54mm pitch available in single and double row.

**SINGLE ROW**

Choice of 2 to 40 ways.

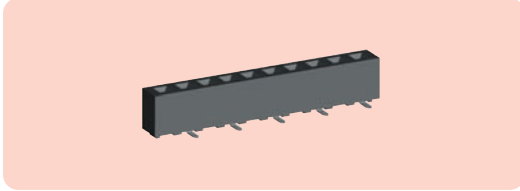

Type	Manf. Part No. & anglia Order Code
<b>STRAIGHT</b>	
2 way	TFH02SSNB
3 way	TFH03SSNB
4 way	TFH04SSNB
5 way	TFH05SSNB
6 way	TFH06SSNB
7 way	TFH07SSNB
8 way	TFH08SSNB
9 way	TFH09SSNB
10 way	TFH10SSNB
11 way	TFH11SSNB
12 way	TFH12SSNB
13 way	TFH13SSNB
14 way	TFH14SSNB
15 way	TFH15SSNB
16 way	TFH16SSNB
17 way	TFH17SSNB
18 way	TFH18SSNB
19 way	TFH19SSNB
20 way	TFH20SSNB
21 way	TFH21SSNB
22 way	TFH22SSNB
23 way	TFH23SSNB
24 way	TFH24SSNB
25 way	TFH25SSNB
26 way	TFH26SSNB
27 way	TFH27SSNB
28 way	TFH28SSNB
29 way	TFH29SSNB
30 way	TFH30SSNB
31 way	TFH31SSNB
32 way	TFH32SSNB
33 way	TFH33SSNB
34 way	TFH34SSNB
35 way	TFH35SSNB
36 way	TFH36SSNB
37 way	TFH37SSNB
38 way	TFH38SSNB
39 way	TFH39SSNB
40 way	TFH40SSNB

**DOUBLE ROW**

Choice of 2 to 40 ways (4 to 80 contacts).

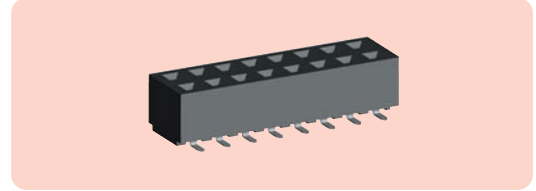

Type	Manf. Part No. & anglia Order Code
<b>STRAIGHT</b>	
2 way	TFH02DSNB
3 way	TFH03DSNB
4 way	TFH04DSNB
5 way	TFH05DSNB
6 way	TFH06DSNB
7 way	TFH07DSNB
8 way	TFH08DSNB
9 way	TFH09DSNB
10 way	TFH10DSNB
11 way	TFH11DSNB
12 way	TFH12DSNB
13 way	TFH13DSNB
14 way	TFH14DSNB
15 way	TFH15DSNB
16 way	TFH16DSNB
17 way	TFH17DSNB
18 way	TFH18DSNB
19 way	TFH19DSNB
20 way	TFH20DSNB
21 way	TFH21DSNB
22 way	TFH22DSNB
23 way	TFH23DSNB
24 way	TFH24DSNB
25 way	TFH25DSNB
26 way	TFH26DSNB
27 way	TFH27DSNB
28 way	TFH28DSNB
29 way	TFH29DSNB
30 way	TFH30DSNB
31 way	TFH31DSNB
32 way	TFH32DSNB
33 way	TFH33DSNB
34 way	TFH34DSNB
35 way	TFH35DSNB
36 way	TFH36DSNB
37 way	TFH37DSNB
38 way	TFH38DSNB
39 way	TFH39DSNB
40 way	TFH40DSNB

**Dimensions (mm)**

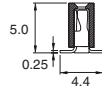
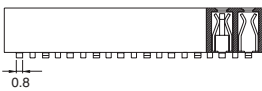

**Pad Pattern**

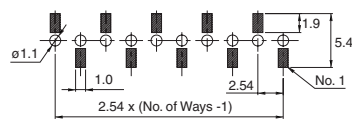
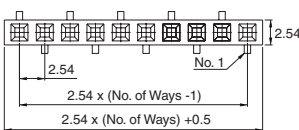

**Dimensions (mm)**

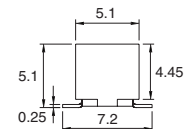
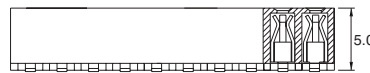

**Pad Pattern**

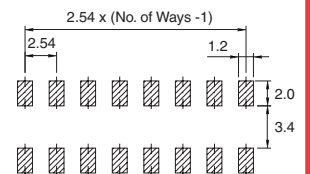
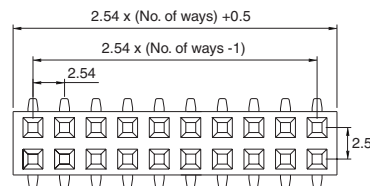

### Through Hole

A range of straight, through hole mounting sockets on a 2.54mm pitch available in single and double row.

#### SINGLE ROW

Choice of 2 to 40 ways.

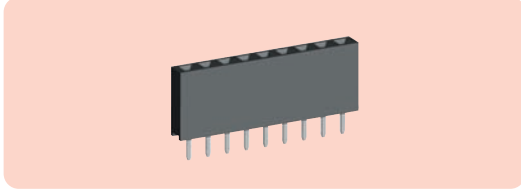

Type	Manf. Part No. & anglia Order Code
<b>STRAIGHT</b>	
2 way	TFH02SS
3 way	TFH03SS
4 way	TFH04SS
5 way	TFH05SS
6 way	TFH06SS
7 way	TFH07SS
8 way	TFH08SS
9 way	TFH09SS
10 way	TFH10SS
11 way	TFH11SS
12 way	TFH12SS
13 way	TFH13SS
14 way	TFH14SS
15 way	TFH15SS
16 way	TFH16SS
17 way	TFH17SS
18 way	TFH18SS
19 way	TFH19SS
20 way	TFH20SS
21 way	TFH21SS
22 way	TFH22SS
23 way	TFH23SS
24 way	TFH24SS
25 way	TFH25SS
26 way	TFH26SS
27 way	TFH27SS
28 way	TFH28SS
29 way	TFH29SS
30 way	TFH30SS
31 way	TFH31SS
32 way	TFH32SS
33 way	TFH33SS
34 way	TFH34SS
35 way	TFH35SS
36 way	TFH36SS
37 way	TFH37SS
38 way	TFH38SS
39 way	TFH39SS
40 way	TFH40SS

#### DOUBLE ROW

Choice of 2 to 40 ways (4 to 80 contacts).

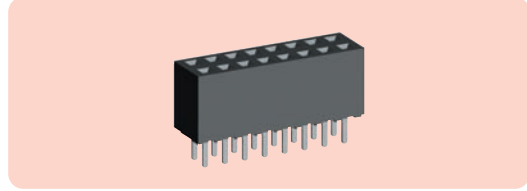

Type	Manf. Part No. & anglia Order Code
<b>STRAIGHT</b>	
2 way	TFH02DS
3 way	TFH03DS
4 way	TFH04DS
5 way	TFH05DS
6 way	TFH06DS
7 way	TFH07DS
8 way	TFH08DS
9 way	TFH09DS
10 way	TFH10DS
11 way	TFH11DS
12 way	TFH12DS
13 way	TFH13DS
14 way	TFH14DS
15 way	TFH15DS
16 way	TFH16DS
17 way	TFH17DS
18 way	TFH18DS
19 way	TFH19DS
20 way	TFH20DS
21 way	TFH21DS
22 way	TFH22DS
23 way	TFH23DS
24 way	TFH24DS
25 way	TFH25DS
26 way	TFH26DS
27 way	TFH27DS
28 way	TFH28DS
29 way	TFH29DS
30 way	TFH30DS
31 way	TFH31DS
32 way	TFH32DS
33 way	TFH33DS
34 way	TFH34DS
35 way	TFH35DS
36 way	TFH36DS
37 way	TFH37DS
38 way	TFH38DS
39 way	TFH39DS
40 way	TFH40DS

Dimensions (mm)

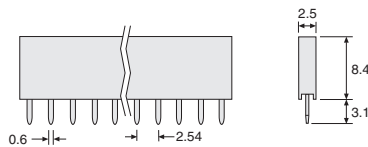

Dimensions (mm)

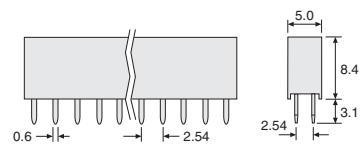

**Through Hole**

A range of right angle, through hole mounting sockets on a 2.54mm pitch available in single and double row.

**SINGLE ROW**

Choice of 2 to 40 ways.

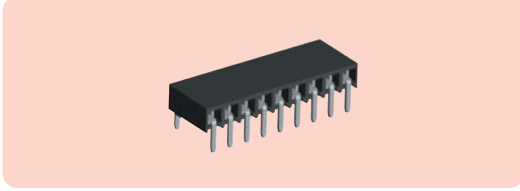

Type	Manf. Part No. & anglia Order Code
RIGHT ANGLE	
2 way	TFH02SR
3 way	TFH03SR
4 way	TFH04SR
5 way	TFH05SR
6 way	TFH06SR
7 way	TFH07SR
8 way	TFH08SR
9 way	TFH09SR
10 way	TFH10SR
11 way	TFH11SR
12 way	TFH12SR
13 way	TFH13SR
14 way	TFH14SR
15 way	TFH15SR
16 way	TFH16SR
17 way	TFH17SR
18 way	TFH18SR
19 way	TFH19SR
20 way	TFH20SR
21 way	TFH21SR
22 way	TFH22SR
23 way	TFH23SR
24 way	TFH24SR
25 way	TFH25SR
26 way	TFH26SR
27 way	TFH27SR
28 way	TFH28SR
29 way	TFH29SR
30 way	TFH30SR
31 way	TFH31SR
32 way	TFH32SR
33 way	TFH33SR
34 way	TFH34SR
35 way	TFH35SR
36 way	TFH36SR
37 way	TFH37SR
38 way	TFH38SR
39 way	TFH39SR
40 way	TFH40SR

**Dimensions (mm)**

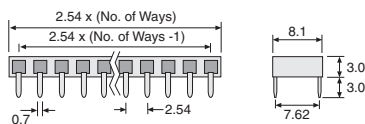

**DOUBLE ROW**

Choice of 2 to 40 ways (4 to 80 contacts).

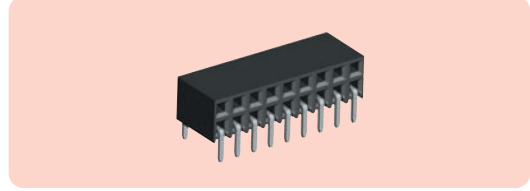

Type	Manf. Part No. & anglia Order Code
RIGHT ANGLE	
3 way	TFH03DR
4 way	TFH04DR
5 way	TFH05DR
6 way	TFH06DR
7 way	TFH07DR
8 way	TFH08DR
9 way	TFH09DR
10 way	TFH10DR
11 way	TFH11DR
12 way	TFH12DR
13 way	TFH13DR
14 way	TFH14DR
15 way	TFH15DR
16 way	TFH16DR
17 way	TFH17DR
18 way	TFH18DR
19 way	TFH19DR
20 way	TFH20DR
21 way	TFH21DR
22 way	TFH22DR
23 way	TFH23DR
24 way	TFH24DR
25 way	TFH25DR
26 way	TFH26DR
27 way	TFH27DR
28 way	TFH28DR
29 way	TFH29DR
30 way	TFH30DR
31 way	TFH31DR
32 way	TFH32DR
33 way	TFH33DR
34 way	TFH34DR
35 way	TFH35DR
36 way	TFH36DR
37 way	TFH37DR
38 way	TFH38DR
39 way	TFH39DR
40 way	TFH40DR

**Dimensions (mm)**

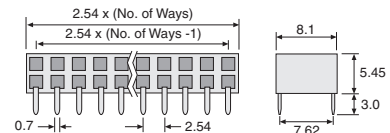

### MINI JUMPER LINKS

2.54mm pitch shorting links for use with the surface mount and through hole 0.64mm square pin headers shown on the previous pages. Contacts gold over nickel plated for higher reliability. Choice of type and colour with other colours available to special volume order. End and side stackable.

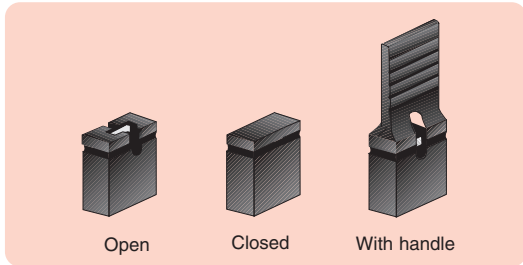

#### Dimensions (mm)

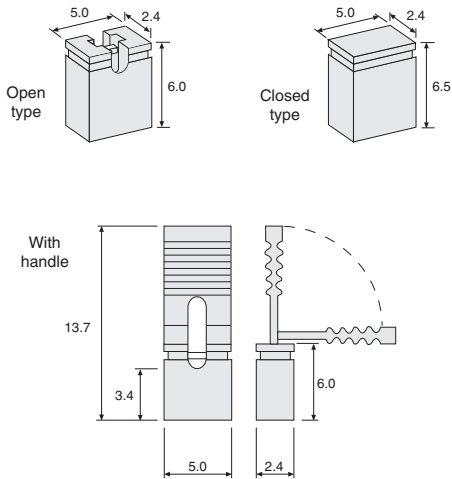

#### Open type

Allows test probe access.

#### Colour

Black  
Red  
Yellow  
Green  
Blue  
White

#### Manf. Part No. & Anglia Order Code

**TMJ00**  
**TMJ02**  
**TMJ04**  
**TMJ05**  
**TMJ06**  
**TMJ09**

#### Closed type

Fully covered link.

#### Colour

Black  
Red  
Yellow  
Green  
Blue  
White

#### Manf. Part No. & Anglia Order Code

**TMJ00C**  
**TMJ02C**  
**TMJ04C**  
**TMJ05C**  
**TMJ06C**  
**TMJ09C**

#### With handle

For easier removal. Test probe access.

#### Colour

Black  
Red  
Yellow  
Green  
Blue  
White

#### Manf. Part No. & Anglia Order Code

**TMJ00H**  
**TMJ02H**  
**TMJ04H**  
**TMJ05H**  
**TMJ06H**  
**TMJ09H**

### EXTENDED PIN HEADERS

The following pages (22 to 28) detail our wide range of extended pin headers that employ double insulators for board spacing applications. Available in a variety of pitches, the most popular lengths are listed for ordering. However, other lengths are available on request – please contact our Sales Desk to discuss your specific requirements.

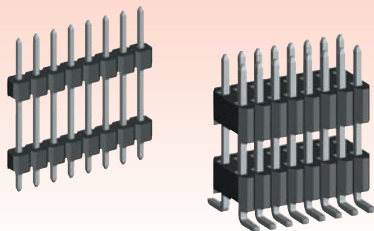

#### Index :

1.27mm Pitch	Pages 22 to 23
1.27 x 2.54mm Pitch	Page 24
2.0mm Pitch	Pages 25 to 26
2.54mm Pitch	Pages 27 to 28

**Surface Mount**

A range of straight, surface mounting, extended pin headers on a 1.27mm pitch available in single and double row.

**SINGLE ROW**

Choice of 2 to 40 ways.

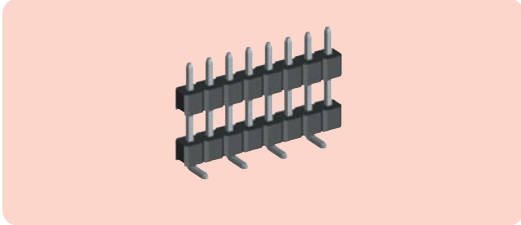

Type	Manf. Part No. & anglia Order Code
<b>STRAIGHT</b>	
2 way	TPH02CSSNBZ
3 way	TPH03CSSNBZ
4 way	TPH04CSSNBZ
5 way	TPH05CSSNBZ
6 way	TPH06CSSNBZ
7 way	TPH07CSSNBZ
8 way	TPH08CSSNBZ
9 way	TPH09CSSNBZ
10 way	TPH10CSSNBZ
11 way	TPH11CSSNBZ
12 way	TPH12CSSNBZ
13 way	TPH13CSSNBZ
14 way	TPH14CSSNBZ
15 way	TPH15CSSNBZ
16 way	TPH16CSSNBZ
17 way	TPH17CSSNBZ
18 way	TPH18CSSNBZ
19 way	TPH19CSSNBZ
20 way	TPH20CSSNBZ
21 way	TPH21CSSNBZ
22 way	TPH22CSSNBZ
23 way	TPH23CSSNBZ
24 way	TPH24CSSNBZ
25 way	TPH25CSSNBZ
26 way	TPH26CSSNBZ
27 way	TPH27CSSNBZ
28 way	TPH28CSSNBZ
29 way	TPH29CSSNBZ
30 way	TPH30CSSNBZ
31 way	TPH31CSSNBZ
32 way	TPH32CSSNBZ
33 way	TPH33CSSNBZ
34 way	TPH34CSSNBZ
35 way	TPH35CSSNBZ
36 way	TPH36CSSNBZ
37 way	TPH37CSSNBZ
38 way	TPH38CSSNBZ
39 way	TPH39CSSNBZ
40 way	TPH40CSSNBZ

**DOUBLE ROW**

Choice of 2 to 40 ways (4 to 80 pins).

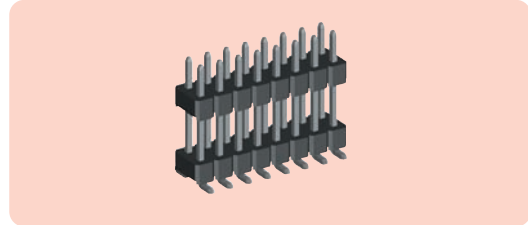

Type	Manf. Part No. & anglia Order Code
<b>STRAIGHT</b>	
2 way	TPH02CDSNBZ
3 way	TPH03CDSNBZ
4 way	TPH04CDSNBZ
5 way	TPH05CDSNBZ
6 way	TPH06CDSNBZ
7 way	TPH07CDSNBZ
8 way	TPH08CDSNBZ
9 way	TPH09CDSNBZ
10 way	TPH10CDSNBZ
11 way	TPH11CDSNBZ
12 way	TPH12CDSNBZ
13 way	TPH13CDSNBZ
14 way	TPH14CDSNBZ
15 way	TPH15CDSNBZ
16 way	TPH16CDSNBZ
17 way	TPH17CDSNBZ
18 way	TPH18CDSNBZ
19 way	TPH19CDSNBZ
20 way	TPH20CDSNBZ
21 way	TPH21CDSNBZ
22 way	TPH22CDSNBZ
23 way	TPH23CDSNBZ
24 way	TPH24CDSNBZ
25 way	TPH25CDSNBZ
26 way	TPH26CDSNBZ
27 way	TPH27CDSNBZ
28 way	TPH28CDSNBZ
29 way	TPH29CDSNBZ
30 way	TPH30CDSNBZ
31 way	TPH31CDSNBZ
32 way	TPH32CDSNBZ
33 way	TPH33CDSNBZ
34 way	TPH34CDSNBZ
35 way	TPH35CDSNBZ
36 way	TPH36CDSNBZ
37 way	TPH37CDSNBZ
38 way	TPH38CDSNBZ
39 way	TPH39CDSNBZ
40 way	TPH40CDSNBZ

**Dimensions (mm)**

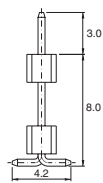
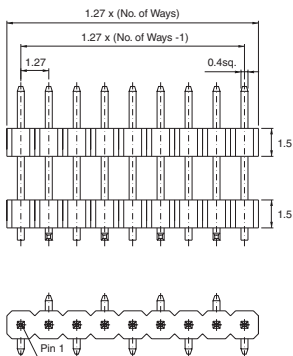

**Pad Pattern**

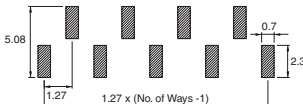

**Dimensions (mm)**

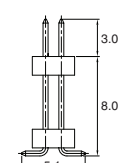
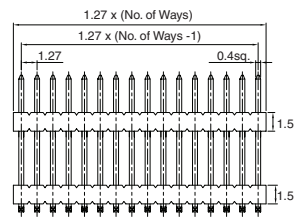

**Pad Pattern**

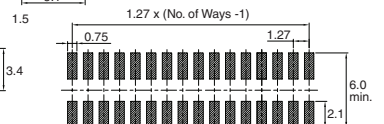

### Through Hole

A range of straight, through hole mounting, extended pin headers on a 1.27mm pitch available in single and double row.

#### SINGLE ROW

Choice of 2 to 40 ways.

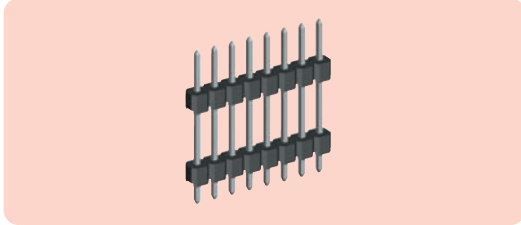

Type	Manf. Part No. & anglia Order Code
<b>STRAIGHT</b>	
2 way	TPH02CSSZ
3 way	TPH03CSSZ
4 way	TPH04CSSZ
5 way	TPH05CSSZ
6 way	TPH06CSSZ
7 way	TPH07CSSZ
8 way	TPH08CSSZ
9 way	TPH09CSSZ
10 way	TPH10CSSZ
11 way	TPH11CSSZ
12 way	TPH12CSSZ
13 way	TPH13CSSZ
14 way	TPH14CSSZ
15 way	TPH15CSSZ
16 way	TPH16CSSZ
17 way	TPH17CSSZ
18 way	TPH18CSSZ
19 way	TPH19CSSZ
20 way	TPH20CSSZ
21 way	TPH21CSSZ
22 way	TPH22CSSZ
23 way	TPH23CSSZ
24 way	TPH24CSSZ
25 way	TPH25CSSZ
26 way	TPH26CSSZ
27 way	TPH27CSSZ
28 way	TPH28CSSZ
29 way	TPH29CSSZ
30 way	TPH30CSSZ
31 way	TPH31CSSZ
32 way	TPH32CSSZ
33 way	TPH33CSSZ
34 way	TPH34CSSZ
35 way	TPH35CSSZ
36 way	TPH36CSSZ
37 way	TPH37CSSZ
38 way	TPH38CSSZ
39 way	TPH39CSSZ
40 way	TPH40CSSZ

#### DOUBLE ROW

Choice of 2 to 40 ways (4 to 80 pins).

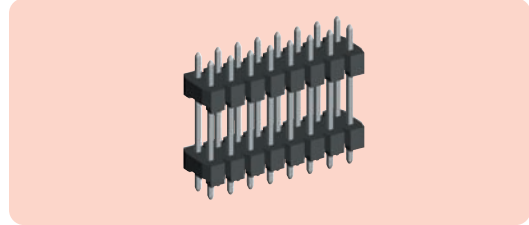

Type	Manf. Part No. & anglia Order Code
<b>STRAIGHT</b>	
2 way	TPH02CDSZ
3 way	TPH03CDSZ
4 way	TPH04CDSZ
5 way	TPH05CDSZ
6 way	TPH06CDSZ
7 way	TPH07CDSZ
8 way	TPH08CDSZ
9 way	TPH09CDSZ
10 way	TPH10CDSZ
11 way	TPH11CDSZ
12 way	TPH12CDSZ
13 way	TPH13CDSZ
14 way	TPH14CDSZ
15 way	TPH15CDSZ
16 way	TPH16CDSZ
17 way	TPH17CDSZ
18 way	TPH18CDSZ
19 way	TPH19CDSZ
20 way	TPH20CDSZ
21 way	TPH21CDSZ
22 way	TPH22CDSZ
23 way	TPH23CDSZ
24 way	TPH24CDSZ
25 way	TPH25CDSZ
26 way	TPH26CDSZ
27 way	TPH27CDSZ
28 way	TPH28CDSZ
29 way	TPH29CDSZ
30 way	TPH30CDSZ
31 way	TPH31CDSZ
32 way	TPH32CDSZ
33 way	TPH33CDSZ
34 way	TPH34CDSZ
35 way	TPH35CDSZ
36 way	TPH36CDSZ
37 way	TPH37CDSZ
38 way	TPH38CDSZ
39 way	TPH39CDSZ
40 way	TPH40CDSZ

#### Dimensions (mm)

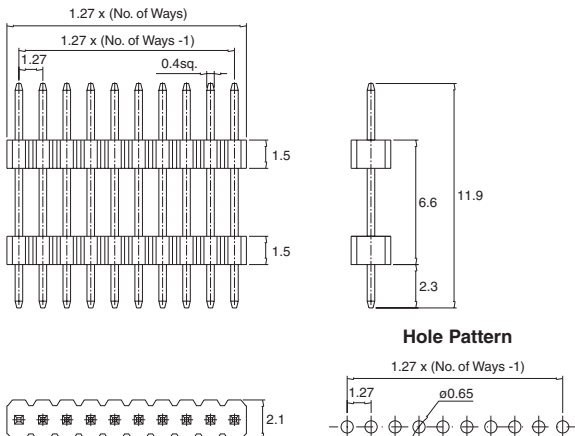

#### Dimensions (mm)

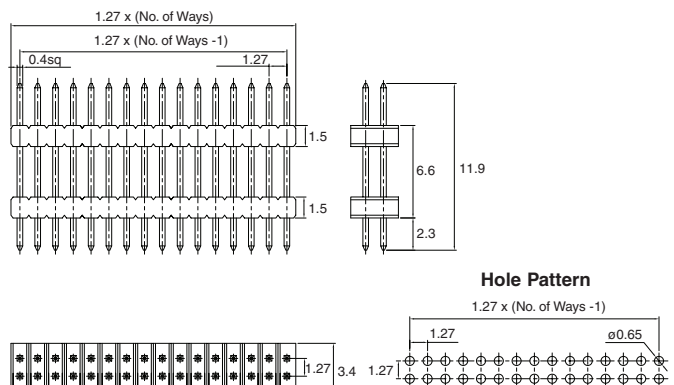



A range of double row, straight, extended pin headers on a 1.27 x 2.54mm pitch available in surface and through hole mounting.

**Surface Mount**

**DOUBLE ROW**

Choice of 2 to 40 ways.

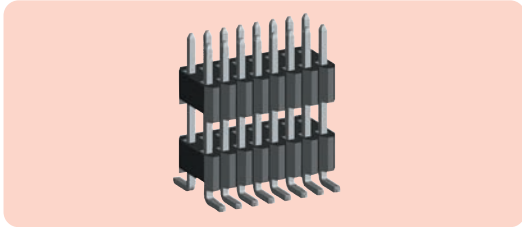

Type	Manf. Part No. & anglia Order Code
<b>STRAIGHT</b>	
2 way	TPH02EDSNBZ
3 way	TPH03EDSNBZ
4 way	TPH04EDSNBZ
5 way	TPH05EDSNBZ
6 way	TPH06EDSNBZ
7 way	TPH07EDSNBZ
8 way	TPH08EDSNBZ
9 way	TPH09EDSNBZ
10 way	TPH10EDSNBZ
11 way	TPH11EDSNBZ
12 way	TPH12EDSNBZ
13 way	TPH13EDSNBZ
14 way	TPH14EDSNBZ
15 way	TPH15EDSNBZ
16 way	TPH16EDSNBZ
17 way	TPH17EDSNBZ
18 way	TPH18EDSNBZ
19 way	TPH19EDSNBZ
20 way	TPH20EDSNBZ
21 way	TPH21EDSNBZ
22 way	TPH22EDSNBZ
23 way	TPH23EDSNBZ
24 way	TPH24EDSNBZ
25 way	TPH25EDSNBZ
26 way	TPH26EDSNBZ
27 way	TPH27EDSNBZ
28 way	TPH28EDSNBZ
29 way	TPH29EDSNBZ
30 way	TPH30EDSNBZ
31 way	TPH31EDSNBZ
32 way	TPH32EDSNBZ
33 way	TPH33EDSNBZ
34 way	TPH34EDSNBZ
35 way	TPH35EDSNBZ
36 way	TPH36EDSNBZ
37 way	TPH37EDSNBZ
38 way	TPH38EDSNBZ
39 way	TPH39EDSNBZ
40 way	TPH40EDSNBZ

**Dimensions (mm)**

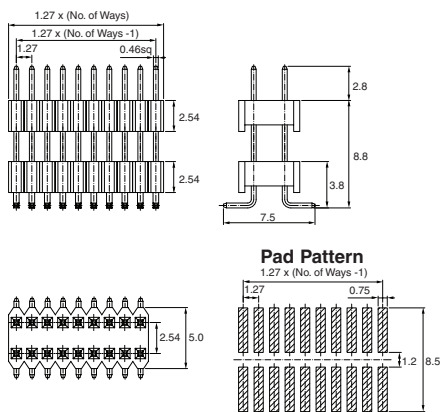

**Through Hole**

**DOUBLE ROW**

Choice of 2 to 40 ways (4 to 80 pins).

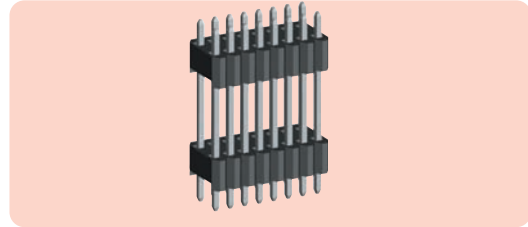

Type	Manf. Part No. & anglia Order Code
<b>STRAIGHT</b>	
2 way	TPH02EDSZ
3 way	TPH03EDSZ
4 way	TPH04EDSZ
5 way	TPH05EDSZ
6 way	TPH06EDSZ
7 way	TPH07EDSZ
8 way	TPH08EDSZ
9 way	TPH09EDSZ
10 way	TPH10EDSZ
11 way	TPH11EDSZ
12 way	TPH12EDSZ
13 way	TPH13EDSZ
14 way	TPH14EDSZ
15 way	TPH15EDSZ
16 way	TPH16EDSZ
17 way	TPH17EDSZ
18 way	TPH18EDSZ
19 way	TPH19EDSZ
20 way	TPH20EDSZ
21 way	TPH21EDSZ
22 way	TPH22EDSZ
23 way	TPH23EDSZ
24 way	TPH24EDSZ
25 way	TPH25EDSZ
26 way	TPH26EDSZ
27 way	TPH27EDSZ
28 way	TPH28EDSZ
29 way	TPH29EDSZ
30 way	TPH30EDSZ
31 way	TPH31EDSZ
32 way	TPH32EDSZ
33 way	TPH33EDSZ
34 way	TPH34EDSZ
35 way	TPH35EDSZ
36 way	TPH36EDSZ
37 way	TPH37EDSZ
38 way	TPH38EDSZ
39 way	TPH39EDSZ
40 way	TPH40EDSZ

**Dimensions (mm)**

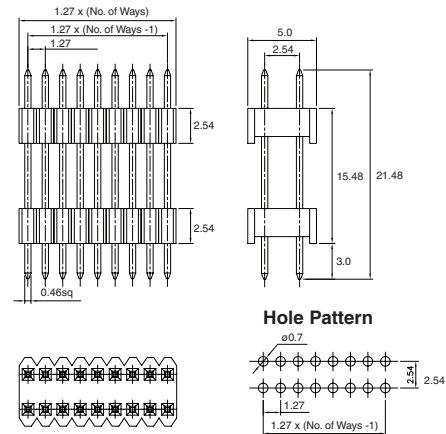

### Surface Mount

A range of straight, surface mounting, extended pin headers on a 2.0mm pitch available in single and double row.

#### SINGLE ROW

Choice of 2 to 40 ways.

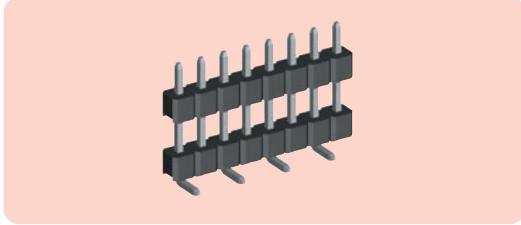

Type	Manf. Part No. & anglia Order Code
<b>STRAIGHT</b>	
2 way	TPH02BSSNBZ
3 way	TPH03BSSNBZ
4 way	TPH04BSSNBZ
5 way	TPH05BSSNBZ
6 way	TPH06BSSNBZ
7 way	TPH07BSSNBZ
8 way	TPH08BSSNBZ
9 way	TPH09BSSNBZ
10 way	TPH10BSSNBZ
11 way	TPH11BSSNBZ
12 way	TPH12BSSNBZ
13 way	TPH13BSSNBZ
14 way	TPH14BSSNBZ
15 way	TPH15BSSNBZ
16 way	TPH16BSSNBZ
17 way	TPH17BSSNBZ
18 way	TPH18BSSNBZ
19 way	TPH19BSSNBZ
20 way	TPH20BSSNBZ
21 way	TPH21BSSNBZ
22 way	TPH22BSSNBZ
23 way	TPH23BSSNBZ
24 way	TPH24BSSNBZ
25 way	TPH25BSSNBZ
26 way	TPH26BSSNBZ
27 way	TPH27BSSNBZ
28 way	TPH28BSSNBZ
29 way	TPH29BSSNBZ
30 way	TPH30BSSNBZ
31 way	TPH31BSSNBZ
32 way	TPH32BSSNBZ
33 way	TPH33BSSNBZ
34 way	TPH34BSSNBZ
35 way	TPH35BSSNBZ
36 way	TPH36BSSNBZ
37 way	TPH37BSSNBZ
38 way	TPH38BSSNBZ
39 way	TPH39BSSNBZ
40 way	TPH40BSSNBZ

#### DOUBLE ROW

Choice of 2 to 40 ways (4 to 80 pins).

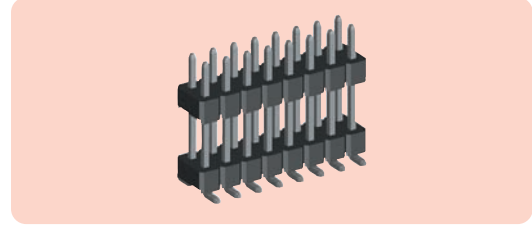

Type	Manf. Part No. & anglia Order Code
<b>STRAIGHT</b>	
2 way	TPH02BDSNBZ
3 way	TPH03BDSNBZ
4 way	TPH04BDSNBZ
5 way	TPH05BDSNBZ
6 way	TPH06BDSNBZ
7 way	TPH07BDSNBZ
8 way	TPH08BDSNBZ
9 way	TPH09BDSNBZ
10 way	TPH10BDSNBZ
11 way	TPH11BDSNBZ
12 way	TPH12BDSNBZ
13 way	TPH13BDSNBZ
14 way	TPH14BDSNBZ
15 way	TPH15BDSNBZ
16 way	TPH16BDSNBZ
17 way	TPH17BDSNBZ
18 way	TPH18BDSNBZ
19 way	TPH19BDSNBZ
20 way	TPH20BDSNBZ
21 way	TPH21BDSNBZ
22 way	TPH22BDSNBZ
23 way	TPH23BDSNBZ
24 way	TPH24BDSNBZ
25 way	TPH25BDSNBZ
26 way	TPH26BDSNBZ
27 way	TPH27BDSNBZ
28 way	TPH28BDSNBZ
29 way	TPH29BDSNBZ
30 way	TPH30BDSNBZ
31 way	TPH31BDSNBZ
32 way	TPH32BDSNBZ
33 way	TPH33BDSNBZ
34 way	TPH34BDSNBZ
35 way	TPH35BDSNBZ
36 way	TPH36BDSNBZ
37 way	TPH37BDSNBZ
38 way	TPH38BDSNBZ
39 way	TPH39BDSNBZ
40 way	TPH40BDSNBZ

#### Dimensions (mm)

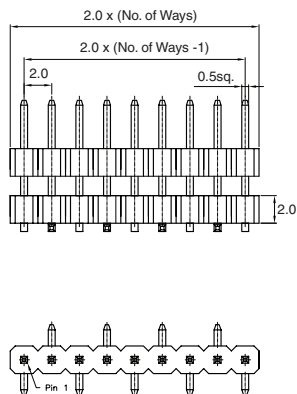

#### Pad Pattern

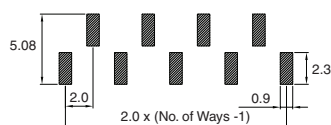

#### Dimensions (mm)

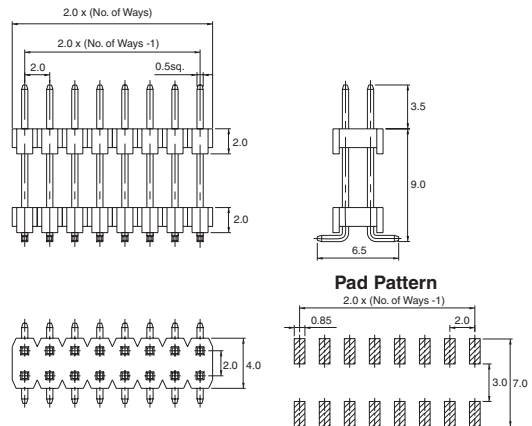

#### Pad Pattern

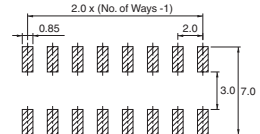

**Through Hole**

A range of straight, through hole mounting, extended pin headers on a 2.0mm pitch. Available in single and double row, each offers the option of either a 6mm or 12mm stacking height.

**SINGLE ROW**

Choice of 2 to 40 ways with option of 6mm or 12mm stacking height.

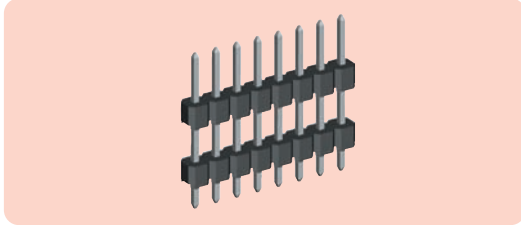

Type	Manf. Part No. & anglia Order Code	
	6mm	12mm
STRAIGHT		
2 way	TPH02BSSZ06	TPH02BSSZ12
3 way	TPH03BSSZ06	TPH03BSSZ12
4 way	TPH04BSSZ06	TPH04BSSZ12
5 way	TPH05BSSZ06	TPH05BSSZ12
6 way	TPH06BSSZ06	TPH06BSSZ12
7 way	TPH07BSSZ06	TPH07BSSZ12
8 way	TPH08BSSZ06	TPH08BSSZ12
9 way	TPH09BSSZ06	TPH09BSSZ12
10 way	TPH10BSSZ06	TPH10BSSZ12
11 way	TPH11BSSZ06	TPH11BSSZ12
12 way	TPH12BSSZ06	TPH12BSSZ12
13 way	TPH13BSSZ06	TPH13BSSZ12
14 way	TPH14BSSZ06	TPH14BSSZ12
15 way	TPH15BSSZ06	TPH15BSSZ12
16 way	TPH16BSSZ06	TPH16BSSZ12
17 way	TPH17BSSZ06	TPH17BSSZ12
18 way	TPH18BSSZ06	TPH18BSSZ12
19 way	TPH19BSSZ06	TPH19BSSZ12
20 way	TPH20BSSZ06	TPH20BSSZ12
21 way	TPH21BSSZ06	TPH21BSSZ12
22 way	TPH22BSSZ06	TPH22BSSZ12
23 way	TPH23BSSZ06	TPH23BSSZ12
24 way	TPH24BSSZ06	TPH24BSSZ12
25 way	TPH25BSSZ06	TPH25BSSZ12
26 way	TPH26BSSZ06	TPH26BSSZ12
27 way	TPH27BSSZ06	TPH27BSSZ12
28 way	TPH28BSSZ06	TPH28BSSZ12
29 way	TPH29BSSZ06	TPH29BSSZ12
30 way	TPH30BSSZ06	TPH30BSSZ12
31 way	TPH31BSSZ06	TPH31BSSZ12
32 way	TPH32BSSZ06	TPH32BSSZ12
33 way	TPH33BSSZ06	TPH33BSSZ12
34 way	TPH34BSSZ06	TPH34BSSZ12
35 way	TPH35BSSZ06	TPH35BSSZ12
36 way	TPH36BSSZ06	TPH36BSSZ12
37 way	TPH37BSSZ06	TPH37BSSZ12
38 way	TPH38BSSZ06	TPH38BSSZ12
39 way	TPH39BSSZ06	TPH39BSSZ12
40 way	TPH40BSSZ06	TPH40BSSZ12

**DOUBLE ROW**

Choice of 2 to 40 ways (4 to 80 pins) with option of 6mm or 12mm stacking height.

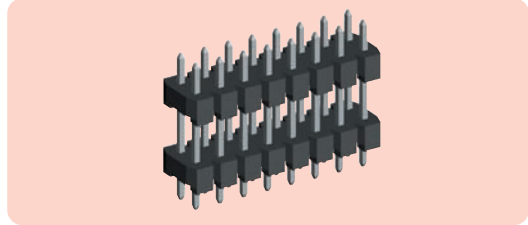

Type	Manf. Part No. & anglia Order Code	
	6mm	12mm
STRAIGHT		
2 way	TPH02BDSZ06	TPH02BDSZ12
3 way	TPH03BDSZ06	TPH03BDSZ12
4 way	TPH04BDSZ06	TPH04BDSZ12
5 way	TPH05BDSZ06	TPH05BDSZ12
6 way	TPH06BDSZ06	TPH06BDSZ12
7 way	TPH07BDSZ06	TPH07BDSZ12
8 way	TPH08BDSZ06	TPH08BDSZ12
9 way	TPH09BDSZ06	TPH09BDSZ12
10 way	TPH10BDSZ06	TPH10BDSZ12
11 way	TPH11BDSZ06	TPH11BDSZ12
12 way	TPH12BDSZ06	TPH12BDSZ12
13 way	TPH13BDSZ06	TPH13BDSZ12
14 way	TPH14BDSZ06	TPH14BDSZ12
15 way	TPH15BDSZ06	TPH15BDSZ12
16 way	TPH16BDSZ06	TPH16BDSZ12
17 way	TPH17BDSZ06	TPH17BDSZ12
18 way	TPH18BDSZ06	TPH18BDSZ12
19 way	TPH19BDSZ06	TPH19BDSZ12
20 way	TPH20BDSZ06	TPH20BDSZ12
21 way	TPH21BDSZ06	TPH21BDSZ12
22 way	TPH22BDSZ06	TPH22BDSZ12
23 way	TPH23BDSZ06	TPH23BDSZ12
24 way	TPH24BDSZ06	TPH24BDSZ12
25 way	TPH25BDSZ06	TPH25BDSZ12
26 way	TPH26BDSZ06	TPH26BDSZ12
27 way	TPH27BDSZ06	TPH27BDSZ12
28 way	TPH28BDSZ06	TPH28BDSZ12
29 way	TPH29BDSZ06	TPH29BDSZ12
30 way	TPH30BDSZ06	TPH30BDSZ12
31 way	TPH31BDSZ06	TPH31BDSZ12
32 way	TPH32BDSZ06	TPH32BDSZ12
33 way	TPH33BDSZ06	TPH33BDSZ12
34 way	TPH34BDSZ06	TPH34BDSZ12
35 way	TPH35BDSZ06	TPH35BDSZ12
36 way	TPH36BDSZ06	TPH36BDSZ12
37 way	TPH37BDSZ06	TPH37BDSZ12
38 way	TPH38BDSZ06	TPH38BDSZ12
39 way	TPH39BDSZ06	TPH39BDSZ12
40 way	TPH40BDSZ06	TPH40BDSZ12

**Dimensions (mm)**

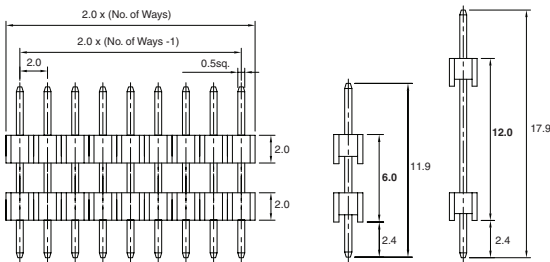

**Hole Pattern**

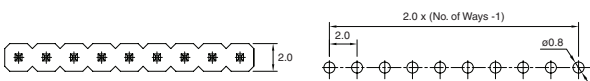

**Dimensions (mm)**

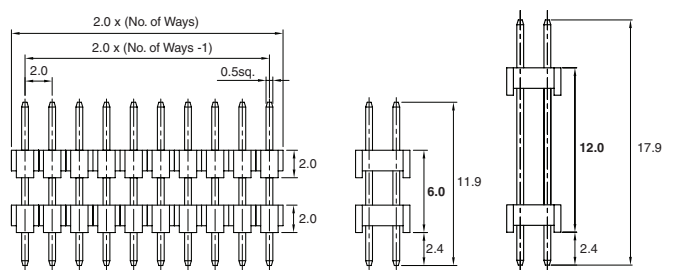

**Hole Pattern**

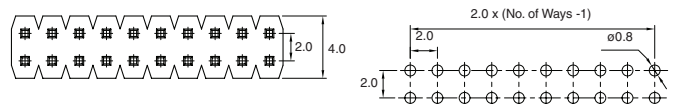

## Surface Mount

A range of straight, surface mounting, extended pin headers on a 2.54mm pitch available in single and double row.

### SINGLE ROW

Choice of 2 to 40 ways.

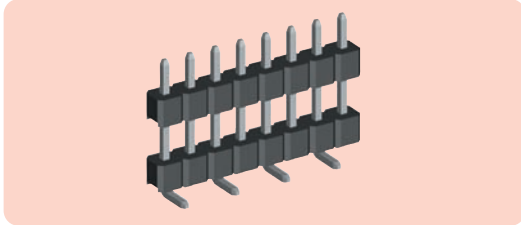

Type	Manf. Part No. & anglia Order Code
<b>STRAIGHT</b>	
2 way	TPH02SSNBZ
3 way	TPH03SSNBZ
4 way	TPH04SSNBZ
5 way	TPH05SSNBZ
6 way	TPH06SSNBZ
7 way	TPH07SSNBZ
8 way	TPH08SSNBZ
9 way	TPH09SSNBZ
10 way	TPH10SSNBZ
11 way	TPH11SSNBZ
12 way	TPH12SSNBZ
13 way	TPH13SSNBZ
14 way	TPH14SSNBZ
15 way	TPH15SSNBZ
16 way	TPH16SSNBZ
17 way	TPH17SSNBZ
18 way	TPH18SSNBZ
19 way	TPH19SSNBZ
20 way	TPH20SSNBZ
21 way	TPH21SSNBZ
22 way	TPH22SSNBZ
23 way	TPH23SSNBZ
24 way	TPH24SSNBZ
25 way	TPH25SSNBZ
26 way	TPH26SSNBZ
27 way	TPH27SSNBZ
28 way	TPH28SSNBZ
29 way	TPH29SSNBZ
30 way	TPH30SSNBZ
31 way	TPH31SSNBZ
32 way	TPH32SSNBZ
33 way	TPH33SSNBZ
34 way	TPH34SSNBZ
35 way	TPH35SSNBZ
36 way	TPH36SSNBZ
37 way	TPH37SSNBZ
38 way	TPH38SSNBZ
39 way	TPH39SSNBZ
40 way	TPH40SSNBZ

### DOUBLE ROW

Choice of 2 to 40 ways (4 to 80 pins).

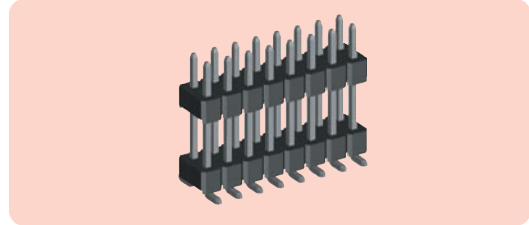

Type	Manf. Part No. & anglia Order Code
<b>STRAIGHT</b>	
2 way	TPH02DSNBZ
3 way	TPH03DSNBZ
4 way	TPH04DSNBZ
5 way	TPH05DSNBZ
6 way	TPH06DSNBZ
7 way	TPH07DSNBZ
8 way	TPH08DSNBZ
9 way	TPH09DSNBZ
10 way	TPH10DSNBZ
11 way	TPH11DSNBZ
12 way	TPH12DSNBZ
13 way	TPH13DSNBZ
14 way	TPH14DSNBZ
15 way	TPH15DSNBZ
16 way	TPH16DSNBZ
17 way	TPH17DSNBZ
18 way	TPH18DSNBZ
19 way	TPH19DSNBZ
20 way	TPH20DSNBZ
21 way	TPH21DSNBZ
22 way	TPH22DSNBZ
23 way	TPH23DSNBZ
24 way	TPH24DSNBZ
25 way	TPH25DSNBZ
26 way	TPH26DSNBZ
27 way	TPH27DSNBZ
28 way	TPH28DSNBZ
29 way	TPH29DSNBZ
30 way	TPH30DSNBZ
31 way	TPH31DSNBZ
32 way	TPH32DSNBZ
33 way	TPH33DSNBZ
34 way	TPH34DSNBZ
35 way	TPH35DSNBZ
36 way	TPH36DSNBZ
37 way	TPH37DSNBZ
38 way	TPH38DSNBZ
39 way	TPH39DSNBZ
40 way	TPH40DSNBZ

#### Dimensions (mm)

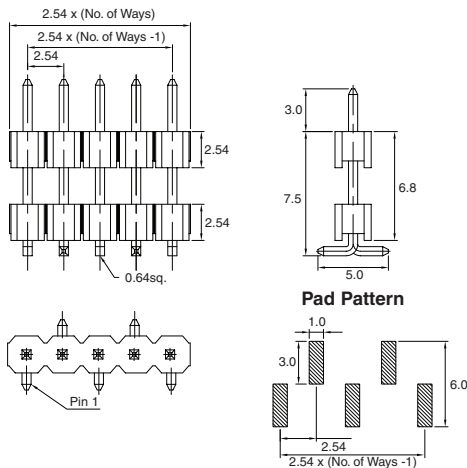

#### Dimensions (mm)

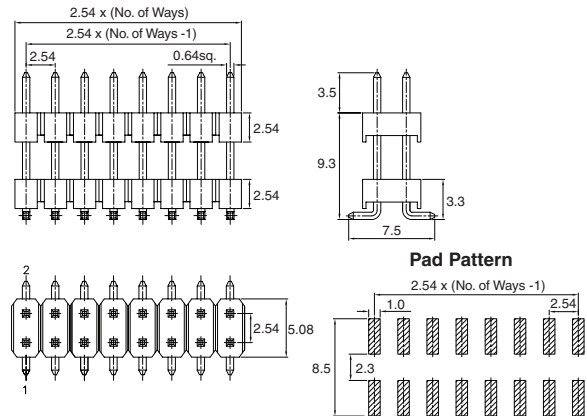

**Through Hole**

A range of straight, through hole mounting, extended pin headers on a 2.54mm pitch available in single and double row.

**SINGLE ROW**

Choice of 2 to 40 ways.

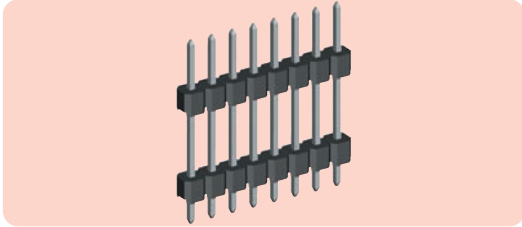

Type	Manf. Part No. & anglia Order Code
<b>STRAIGHT</b>	
2 way	TPH02SSZ
3 way	TPH03SSZ
4 way	TPH04SSZ
5 way	TPH05SSZ
6 way	TPH06SSZ
7 way	TPH07SSZ
8 way	TPH08SSZ
9 way	TPH09SSZ
10 way	TPH10SSZ
11 way	TPH11SSZ
12 way	TPH12SSZ
13 way	TPH13SSZ
14 way	TPH14SSZ
15 way	TPH15SSZ
16 way	TPH16SSZ
17 way	TPH17SSZ
18 way	TPH18SSZ
19 way	TPH19SSZ
20 way	TPH20SSZ
21 way	TPH21SSZ
22 way	TPH22SSZ
23 way	TPH23SSZ
24 way	TPH24SSZ
25 way	TPH25SSZ
26 way	TPH26SSZ
27 way	TPH27SSZ
28 way	TPH28SSZ
29 way	TPH29SSZ
30 way	TPH30SSZ
31 way	TPH31SSZ
32 way	TPH32SSZ
33 way	TPH33SSZ
34 way	TPH34SSZ
35 way	TPH35SSZ
36 way	TPH36SSZ
37 way	TPH37SSZ
38 way	TPH38SSZ
39 way	TPH39SSZ
40 way	TPH40SSZ

**Dimensions (mm)**

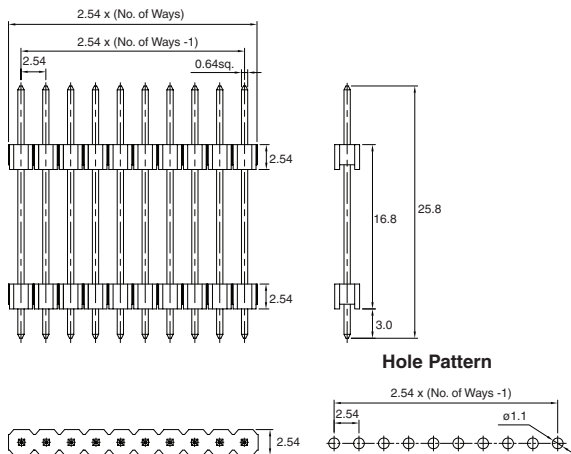

**DOUBLE ROW**

Choice of 2 to 40 ways (4 to 80 pins)

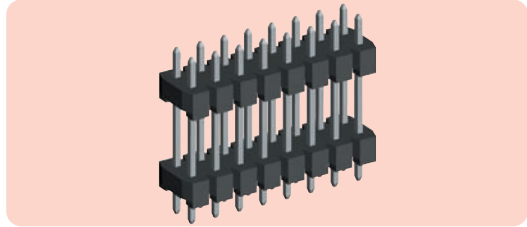

Type	Manf. Part No. & anglia Order Code
<b>STRAIGHT</b>	
2 way	TPH02DSZ
3 way	TPH03DSZ
4 way	TPH04DSZ
5 way	TPH05DSZ
6 way	TPH06DSZ
7 way	TPH07DSZ
8 way	TPH08DSZ
9 way	TPH09DSZ
10 way	TPH10DSZ
11 way	TPH11DSZ
12 way	TPH12DSZ
13 way	TPH13DSZ
14 way	TPH14DSZ
15 way	TPH15DSZ
16 way	TPH16DSZ
17 way	TPH17DSZ
18 way	TPH18DSZ
19 way	TPH19DSZ
20 way	TPH20DSZ
21 way	TPH21DSZ
22 way	TPH22DSZ
23 way	TPH23DSZ
24 way	TPH24DSZ
25 way	TPH25DSZ
26 way	TPH26DSZ
27 way	TPH27DSZ
28 way	TPH28DSZ
29 way	TPH29DSZ
30 way	TPH30DSZ
31 way	TPH31DSZ
32 way	TPH32DSZ
33 way	TPH33DSZ
34 way	TPH34DSZ
35 way	TPH35DSZ
36 way	TPH36DSZ
37 way	TPH37DSZ
38 way	TPH38DSZ
39 way	TPH39DSZ
40 way	TPH40DSZ

**Dimensions (mm)**

